



Just For Openers

M-3-26

6126 McPHERSON, ST. LOUIS, MO 63112

(314) 863-6798

APR 1992
ISSUE 54

THERE IS STILL TIME TO REGISTER FOR THE CONVENTION. SEE PAGE 24 FOR DETAILS

THE JFO WELCOMES THESE 22 NEW MEMBERS: CHRIS AFFOLTER, KURT BACHMANN, RONALD BEHNKEN, GERALD BERGHOLD, JOHN CARTWRIGHT, DON DAVIDSHOFER, RON DEFERE, DAVE DERRICK, STEPHANIE GOLDIE, EDITH GRISHAM, HARVEY HANSEN, GEORGE HOFFMANN, JAMES MAHLER, PETER MALLOY, DONALD MUELLER, STEVE OWEN, DAVID PERKINS, TONY SCHNEIDER, KATHERYN SHERRARD, LARRY STEVENS, RON VYCE, TED WARNER. I WANT TO THANK THE MEMBERS WHO INVITED THEM TO JOIN US.

(RESPONSE: JOE YOUNG PG. 1 JFO-530 WELL, I'VE GOT ONE ALSO-EXCEPT THERES A COUPLE DIFFERENCES BETWEEN WHAT HE'S SHOWING & THE ONE I HAVE. FIRST; THE DATE IS CLEARLY LEGIBLE ON MINE & IT STATES "PAT. SEPT. 15-08" (HE SAID 16). SECOND; ON THE LARGER FRONT RING THERE IS A SMALL TAB EXTENDING IN TOWARDS THE CENTER. ALSO THE ELEVATED LARGE TAB APPEARS TO BE CONSIDERABLY LARGER THAN HIS VIEW. IT IS OBVIOUSLY AN OPENER BUT I DON'T THINK FOR BEVERAGES. IT HAS THE APPEARANCE OF A SPANNER WRENCH TO INDEX INTO WHAT-EVER SLOTS OR INDENTIONS APPROPRIATE. THE STEEL STOCK IS QUITE HEFTY WHICH TO ME INDICATES THE OPENING OF A PRESSURE VALVE SUCH AS A CO-2 TANK ETC. BUT I STILL DON'T KNOW ANYMORE THAN JOE DOES. DICK BRITTON

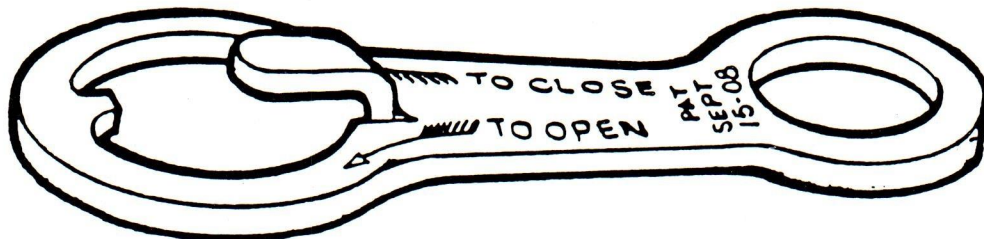

BUY - SELL - TRADE

FOR SALE: EVERYTHING; Bottles, Openers, Posters, Corkscrews.
Send L.S.A.S.E. FOR LIST.
Roger A. Burke 6565 W. 8000 N. Tremonton, UT. 84337

FOR SALE: JFO pins & shoulder patches - \$4.50 each postpaid.
The Supplement to the Handbook- \$7.00 each postpaid.
Ed Kaye 1478 Albatross Rd. Sanibel Island, FL. 33957

WANTED: Your 0-5 style openers by Starr X. BEER-NONBEER-FOREIGN.
Steve Owen 5409 Carmel Ct. Tyler, TX. 75703

FOR TRADE: Soda Openers; A-43 (horse) Drink Penn-Cola, & and a B-59
"Drink Chero-Cola" John Stanley, 605 Windsong, Duram, NC. 27713

WANTED: Unusal A-types (Figurals); Harley-Davidson Biker, Goodyear
Airplane, Canadian Chainsaw, etc. Beer-Nonbeer. Cash or Trade.
Tony Zanghi, 2225 Deer Trail Rd. Coopersburg, PA. 18036 (215) 346-8232



This issue of Opener Trivia is dedicated to the members of JFO who collect corkscrews. I have heretofore refrained from doing an entire issue on their special area of collecting because most of our members are interested in beer advertising openers. However, every year several corkscrew collectors attend our annual JFO con-

vention and have become an integral part of our club. Herb Danziger and Lehr Roe hosted JFO Convention XI in Frankenmuth, Michigan and they along with Bob Nugent, Joe Paradi, and Joe Young are in attendance almost every year. THIS ONE'S FOR YOU SCREWED UP PEOPLE WHO COLLECT THESE WIERD OBJECTS!

The drawings in this issue were made over a period of years. Although I never have been an avid collector of corkscrews I've always picked up those that seemed interesting or unusual. Most of them I either traded or sold, but before I let them go I usually made a drawing to remember what they looked like. Some of my early drawings were not very accurate. I usually quickly traced around the corkscrew and then drew in any wording that appeared on it without regard to the exact spacing or shape of the letters. For this reason I cannot guarantee the accuracy of these drawings and have coded them with four dots :: under the number of the corkscrew. A full explanation of my coding system appears at the end of this issue.

Where I could I have touched up some of my older drawings adding details to them that I knew I had omitted. I have tried to put in a good variety of specimens so that it will be of interest to everyone. Note that all of the drawings have been reduced so that I could include more of them on each page. Actual measurements are noted in my comments. I in no way pretend to be an expert on corkscrews and I welcome any additional comments and/or corrections regarding any of them. I will include them in the next issue.

ABOUT THE OPENERS

- ① A pewter wine tasting spoon marked Joseph Copeland 1675 (?). Reverse is marked "STIEFF - PEWTER". Actual length = 7 13/16"
- ② An unlisted P-26 type knife from the Neef Bros. Brewing Co., Denver, Col. (1896 - 1915). Steel sides with engraved lettering. Actual length = 3 5/16"
- ③ A high quality brass deer's head corkscrew with black accents. Length (base to tip of corkscrew) = 3 1/4"
- ④ A humongous novelty corkscrew measuring 10 5/16" from the tip of the hat to the tip of the corkscrew. The word "Hici!" appears on the reverse side of the head. Made in Italy.
- ⑤ Olive green handle. Side of bell is marked "GERMANY". Have seen others of this type only without a spring. Actual length = 4 1/16"
- ⑥ Corkscrew made by the Haff Manufacturing Co. of New York, circa 1885. Metal band around handle is marked "PATENT APPLIED FOR". Actual length = 5 1/8"
- ⑦ Unusual corkscrew made of steel wire (Henry Bodnar collection). Actual length = 4 1/16"
- ⑧ B-13 type opener-corkscrew. No advertising on reverse. Actual length = 2 7/8"
- ⑨ An interesting little corkscrew. Actual length = 3"
- ⑩ B-13-35 Actual length = 2 7/8"
- ⑪ A very high quality corkscrew with a stag horn handle. Unusual because it has a ball bearing mechanism in the part where the shaft and frame join (see arrow). Plated. No markings. Actual length = 5 5/16"
- ⑫ A neat key type opener-corkscrew made by Brown & Bigelow, St. Paul, Minnesota. I have only seen one other of these which was marked "Your Key to Saint Paul 1933". Actual length (with corkscrew in sleeve) = 3 3/16"
- ⑬ A very nice nickel plated combination tool consisting of a cap lifter, 2 hammers, and 5 fold out tools (2 chisels, punch, screwdriver, and a corkscrew). Metal band (see arrow) slides upward to release tools. Actual length = 4 1/2"

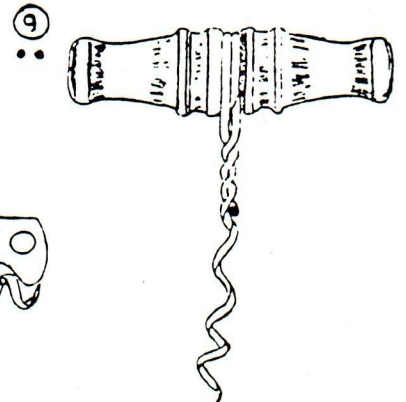
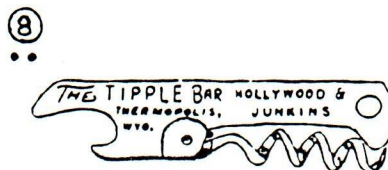
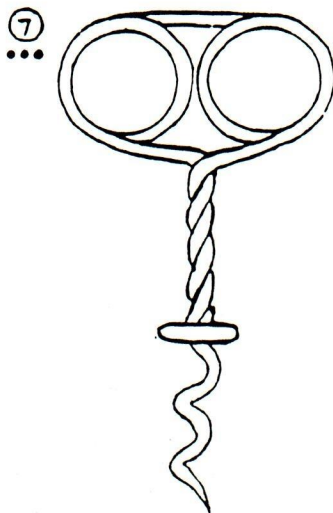
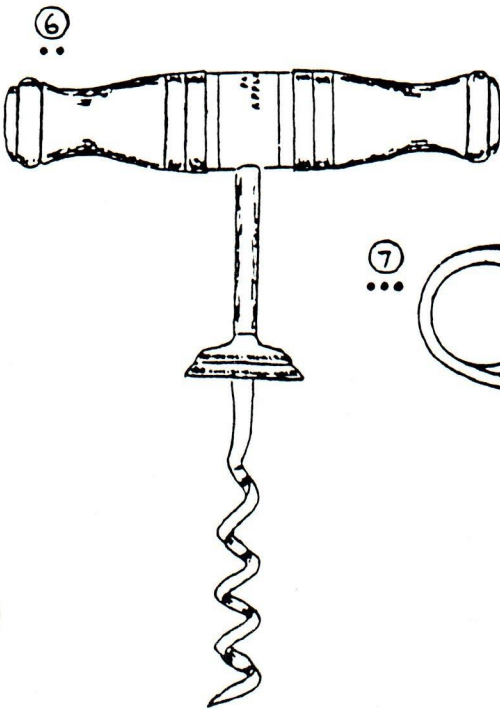
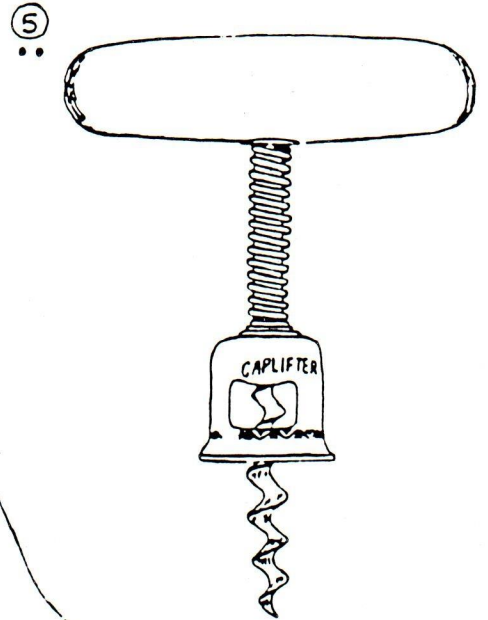
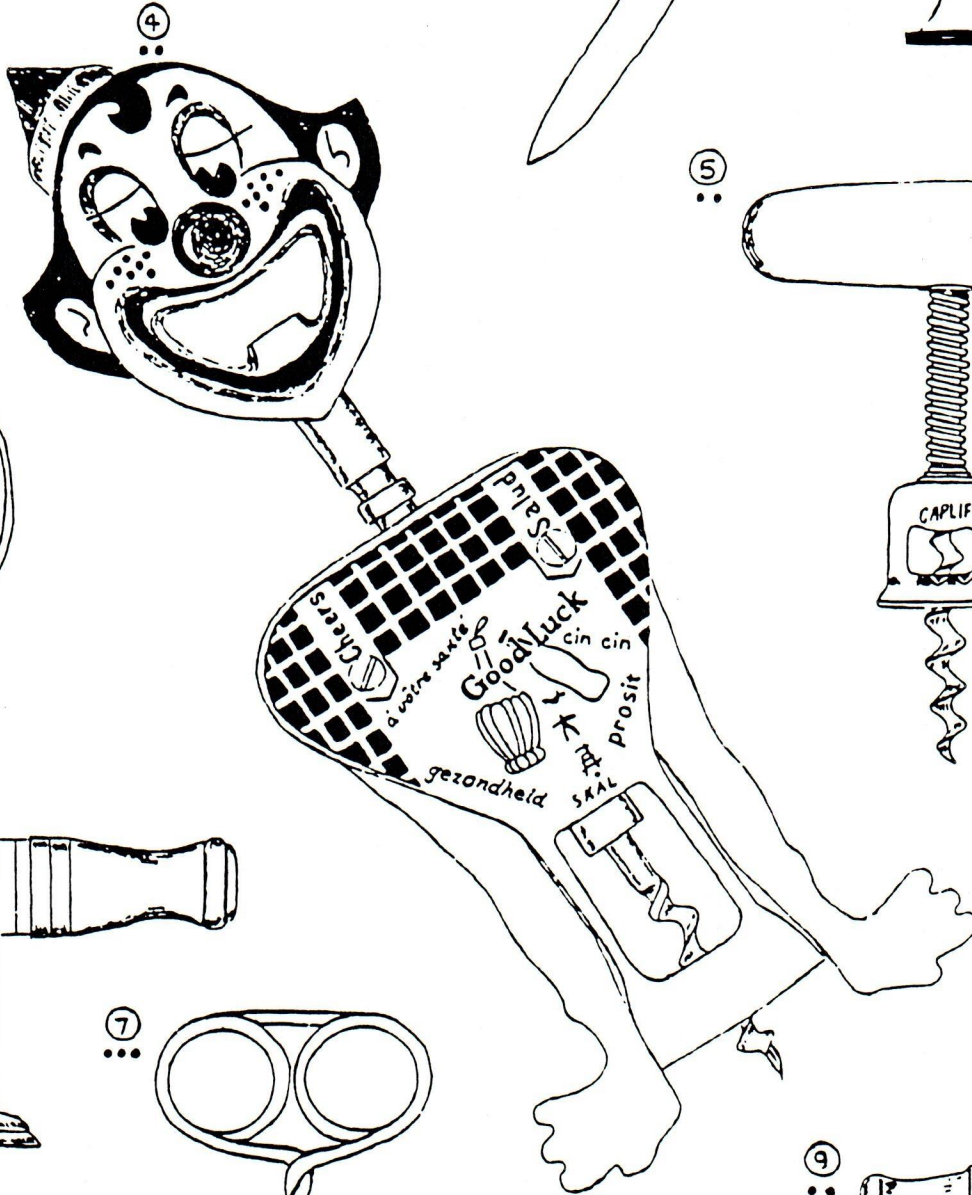
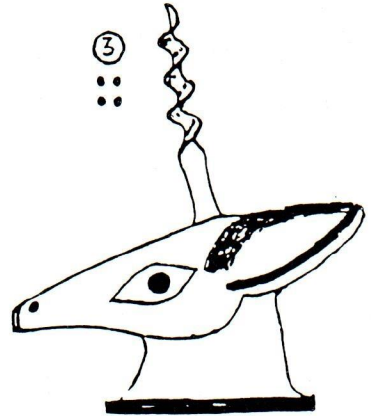
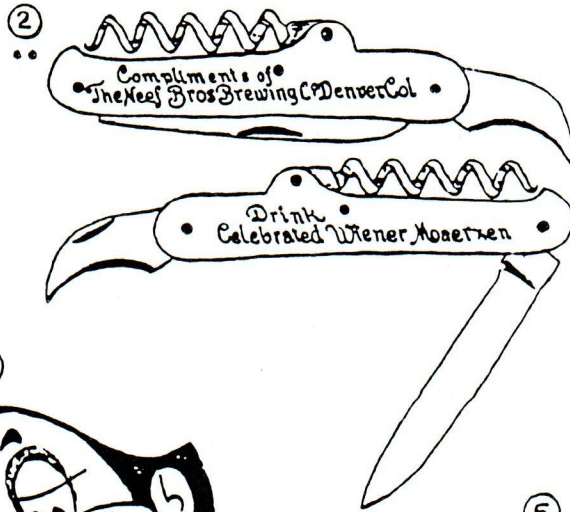
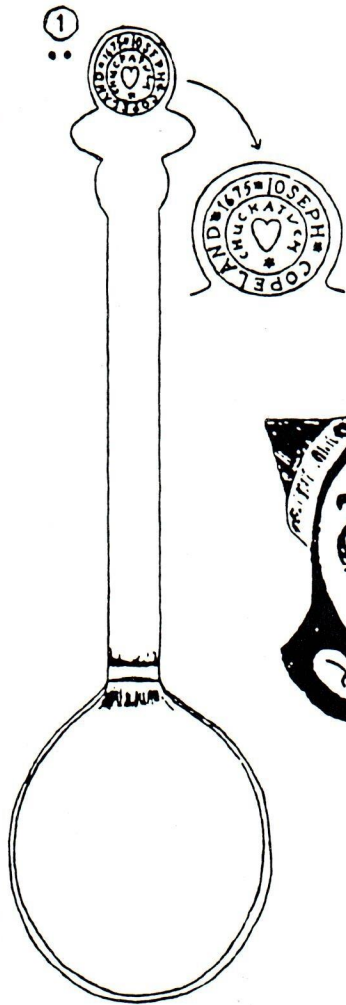

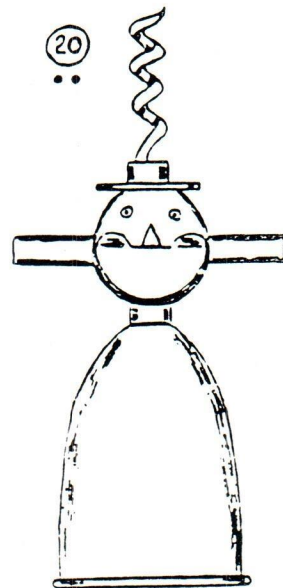
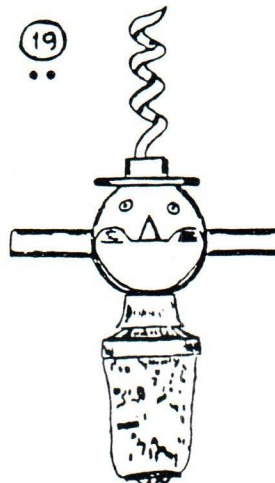
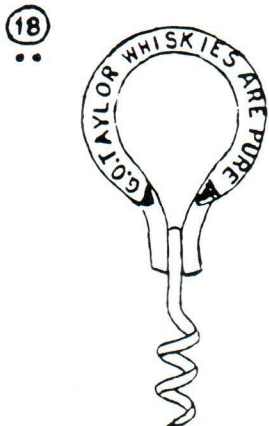
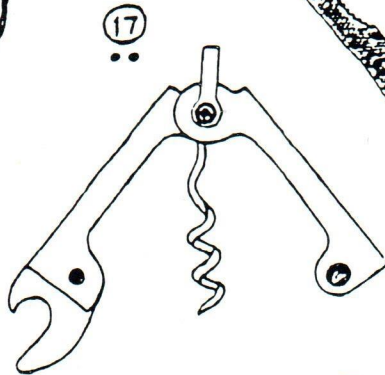
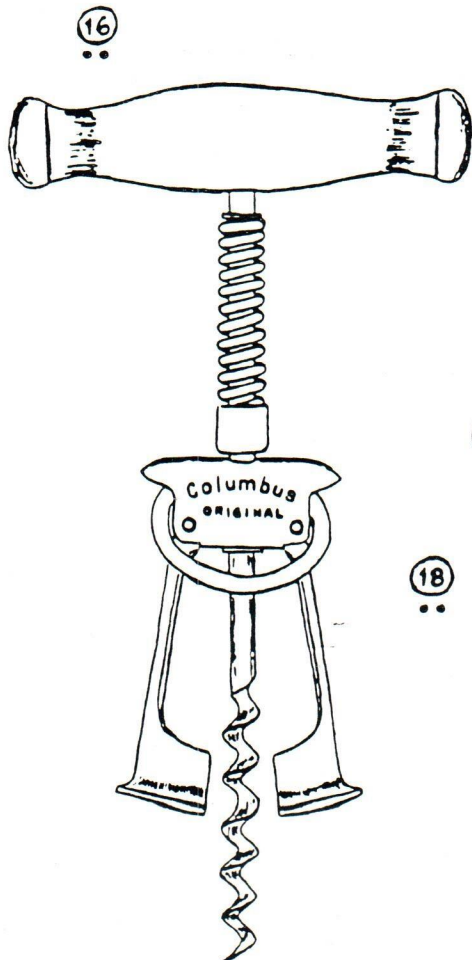
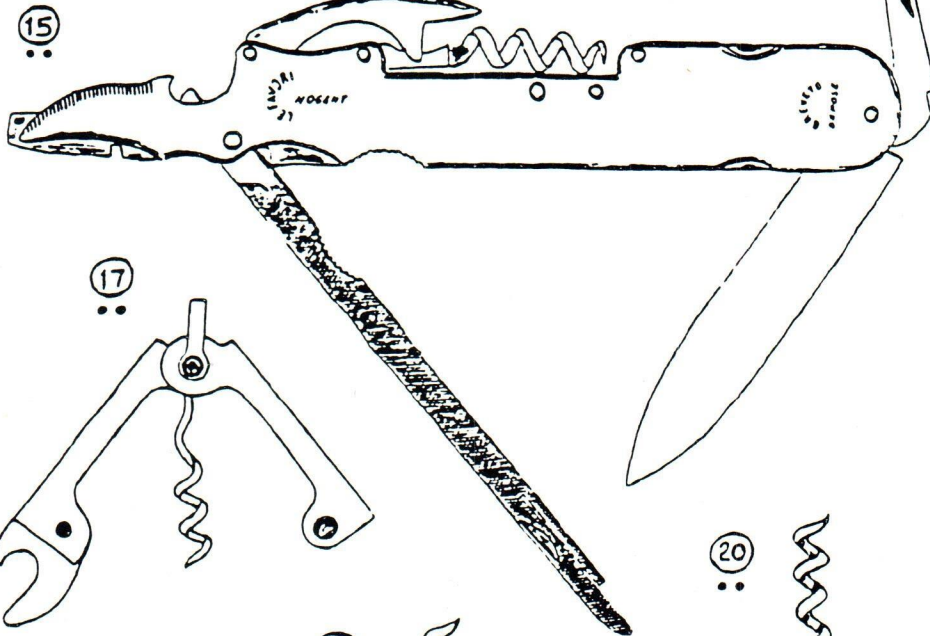
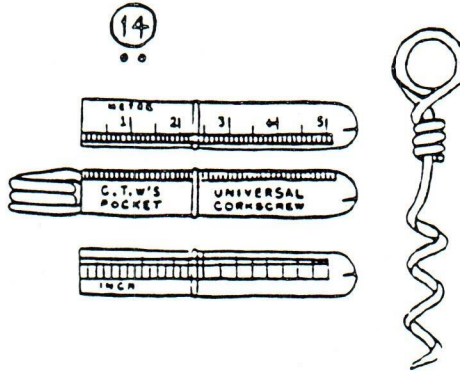
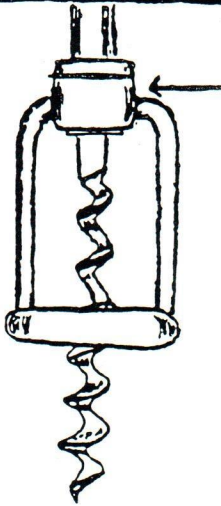
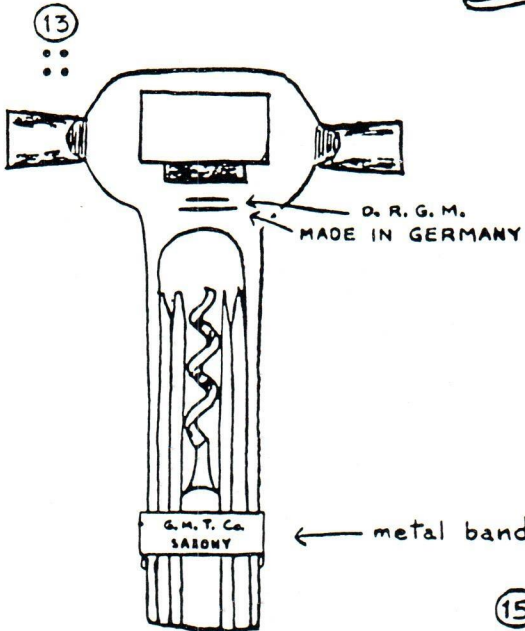
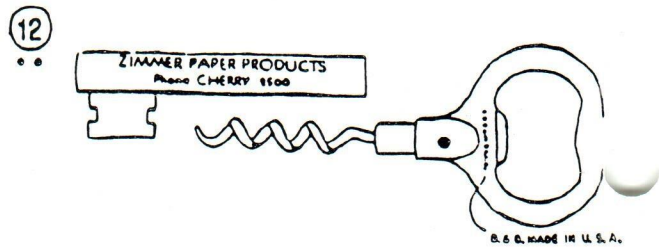
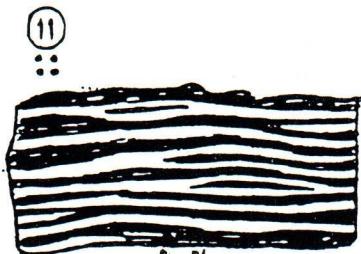
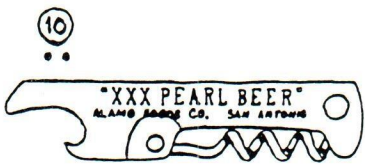

21
::

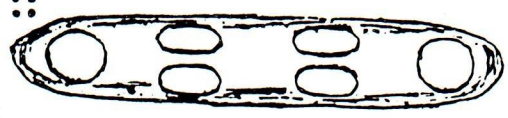

top view
of handle



this part
slides up
and down

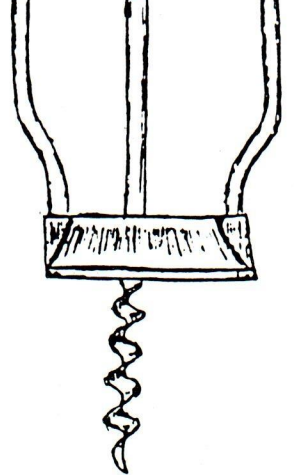

22
::

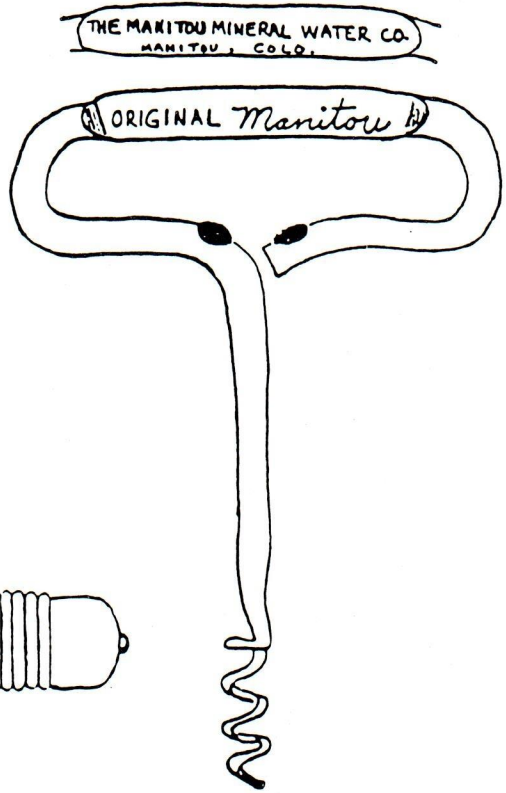

23
::

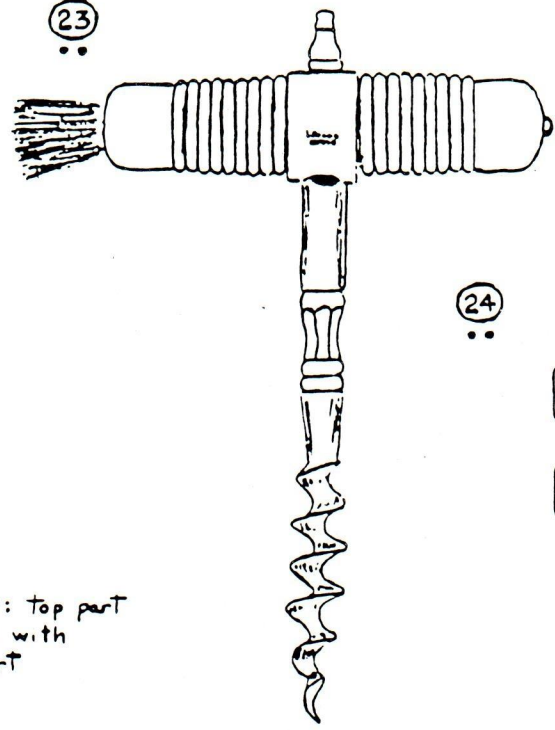

24
::

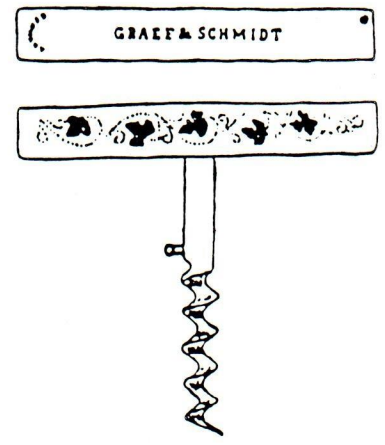

25
::

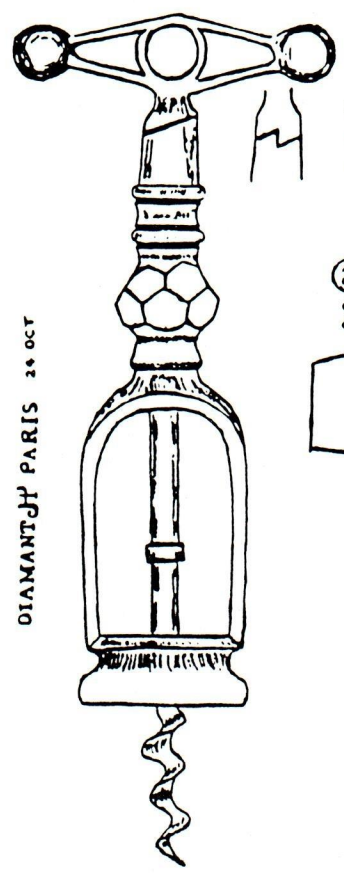

side view: top part
interlocks with
middle part

26
::



27
::

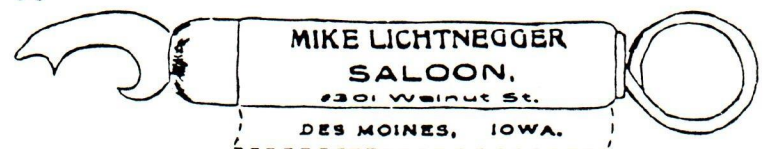

DAMANT JY PARIS 25 OCT

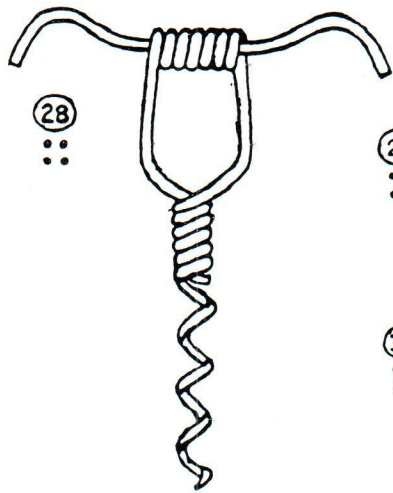

29

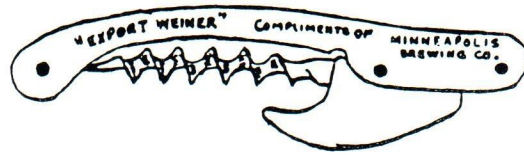

30



31

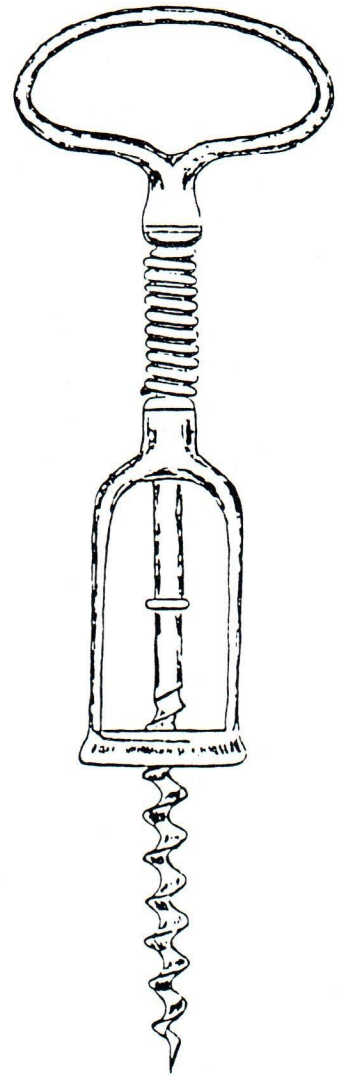

32

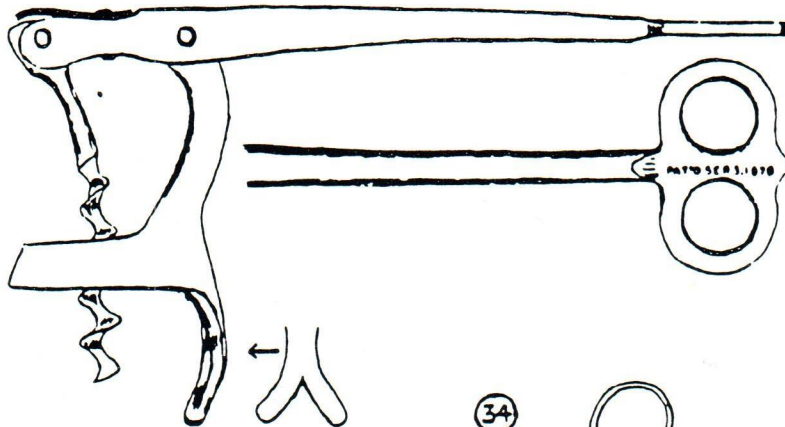

34

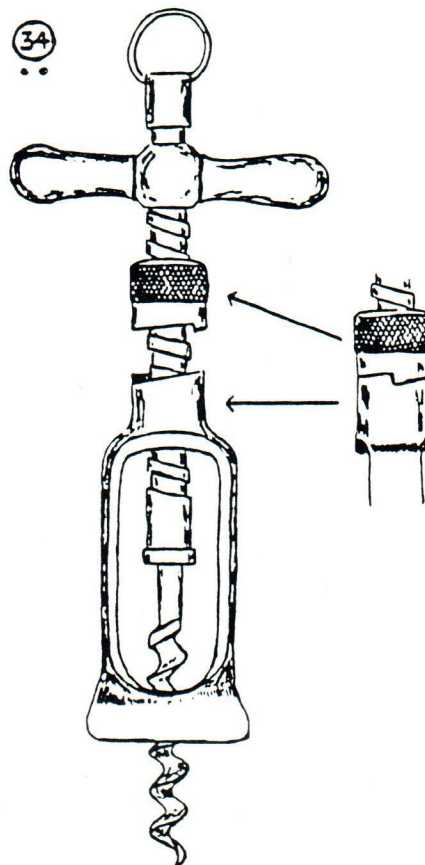

33

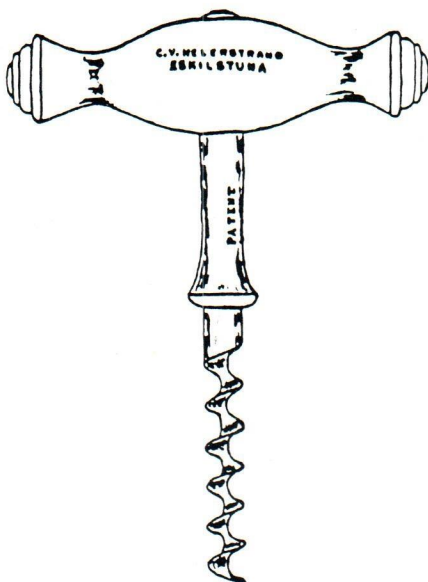

35

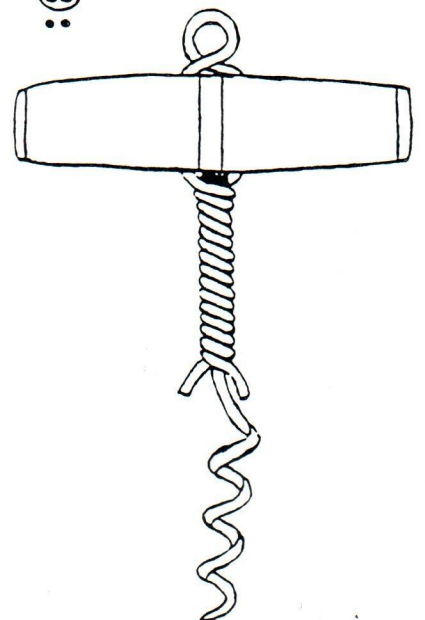

ABOUT THE OPENERS

- ⑭ Pocket corkscrew in metal sleeve. Shown are three views of the sleeve. C.T.W'S probably stands for C. T. Williamson of Newark, N.J. Actual length (with corkscrew in sleeve) = 2 13/16"
- ⑮ This is "The mother of all bartender's tools". It was designed by Saddam Hussein for his troops during the War in the Gulf. It has a 3 1/2" knife blade for hand to hand combat and a corkscrew to open the bottles during the post war celebration over the "capitalist scum". Illustrated here is the Junior Model for soldiers 18 years of age and under. Nine uses. Actual length = 7"
- ⑯ Early 20th century German patent by Becker. Split cage design with ring. Spring over shank. Black wooden handle. Actual length = 7 1/8"
- ⑰ A folding corkscrew with an A type bottle opener on one end of the handle. Profile of an Indian in full head dress with word "CHIEF" appears on reverse side. Marked "MADE IN USA". Actual length (not counting ring on top) = 2 7/8"
- ⑱ A small folding corkscrew. Reverse reads "DRINK HUB PUNCH". Actual length = 3 1/4"
- ⑲ A novelty bottle stopper with a bottle opener and corkscrew. Bottle opener is mouth. Black metal sleeve fits over corkscrew. Actual length = 3 15/16"
- ⑳ Companion piece to corkscrew ⑲. Bottom part is a cup for measuring liquor. Actual length = 4 11/16"
- ㉑ An unusual corkscrew whose handles remind me of some of the parts I have seen on old time stoves. Could it have been made by a stove company? No markings. Actual length (top of the handle to the tip of the corkscrew) = 6 3/16"
- ㉒ A wire formed corkscrew probably made by the same company that made beer advertising type F-16. This piece is from Colorado and it is the only one I have ever seen. Actual length = 5 5/8"
- ㉓ A nice old French corkscrew marked "LB PARIS DEPOSE". Actual length = 5 11/16"
- ㉔ A beautiful little corkscrew made in GERMANY. Fancy work appears on both sides of the handle. Shown are top view, side view, and bottom view with corkscrew folded inside handle. Actual length (tip of corkscrew to top of handle) = 2 3/4"
- ㉕ Early 20th Century French Mechanical corkscrew marked "JHP" (J. H. Perille). Actual length = 7"
- ㉖ P-90-UL A.Hupfel's Son's BREWERY NEW YORK U.S.A. / "OLD SETTER BRAND" Actual length = 4 1/2"
- ㉗ Type P-7 opener-corkscrew. Patented in 1901. Don't see many openers or corkscrews with saloon advertising. Actual length = 5 15/16"
- ㉘ One continuous piece of wire has been twisted around a second piece of wire which forms the handle. Definitely a manufactured piece. Wonder if it was ever patented (?). Actual length (top of handle to tip of corkscrew) = 3 7/8"
- ㉙ P-2-2 Minneapolis Brewing Co. Patented by D.W.Davis on July 14, 1891. Actual length = 4 1/8"
- ㉚ P-2-6 Minneapolis Brewing Co. Compare the corkscrew on this example with the corkscrew on P-2-2.
- ㉛ A monstrous corkscrew with an interesting circular handle. No markings. Actual length = 8 7/16"
- ㉜ An early American corkscrew patented by W.W.Tucker Hartford, Connecticut on Sept. 3, 1878. Actual length = 6 1/4"
- ㉝ A late 19th Century piece. Reverse is marked "PRISBELÄNT PHILADELPHIA 1876". Actual length = 4 11/16"
- ㉞ An unusual corkscrew with an interlocking mechanism at the top. No markings. Actual length (tip of corkscrew to top, not counting ring) = 6 1/2"
- ㉟ Haven't seen another wooden handled corkscrew constructed in quite this manner. A piece of steel wire runs through two holes in the handle to form the loop on the top of the corkscrew. This same piece of wire was then twisted around a second piece of wire to form the corkscrew. Actual length = 4 15/16"

CODING SYSTEM FOR DRAWINGS

- | | |
|---|---|
| <p>○ This drawing was made from copying a xerox.</p> <p>○ This drawing was sent to me by the owner of the opener.</p> | <p>○ This drawing was made from the actual opener.</p> <p>○ This is one of my early drawings.</p> |
|---|---|

NOTE THAT I CAN ONLY GUARANTEE ACCURACY ON THOSE OPENERS CODED WITH TWO DOTS.

OPENER COLLECTOR OF THE MONTH

I STARTED OUT AS A BEER CAN COLLECTOR IN 1970. IN 1977 I HAD NO MORE ROOM FOR CANS SO I STARTED COLLECTING BREWERY ADVERTISING OPENERS.

I SAW AN AD IN A 1981 BCCA NEWS REPORT WHICH READ "LETS TRADE OPENERS". THE AD WAS PUT IN BY TED STRINY WHO SUGGESTED THAT I JOIN THE JFO. FROM THAT TIME ON MY COLLECTION STARTED GROWING AS I TRADED WITH OTHERS.

I ATTENDED MY FIRST JFO CONVENTION IN 1987 AND ONLY MISSED ONE SINCE THEN. I NOW LOOK FORWARD TO ATTENDING THEM AND RENEWING THE FRIENDSHIP OF ALL THE MEMBERS.

MY COLLECTION NOW HAS ABOUT 3100 OPENERS OF ALL TYPES. BESIDE TRADING I ATTEND A LOT OF FLEA MARKETS AND BREWERIAN SHOWS TO FIND OPENERS.

BEN HOFFMAN

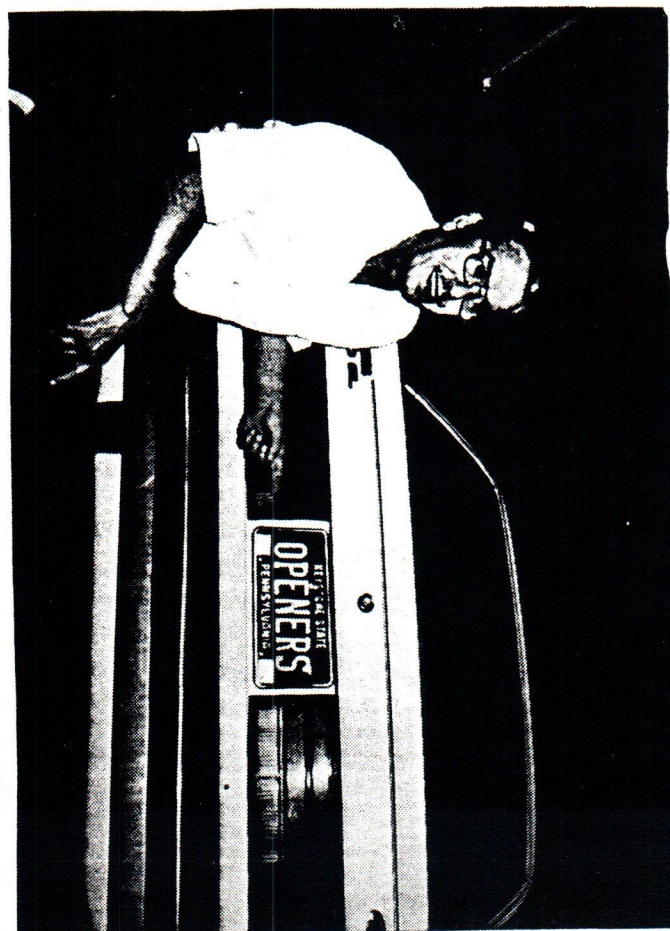
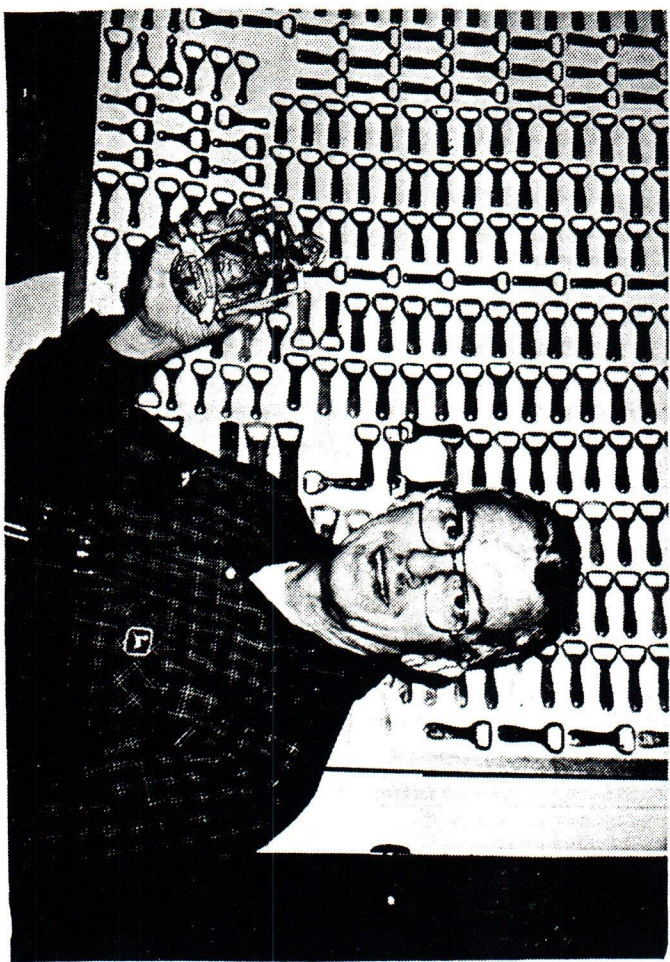

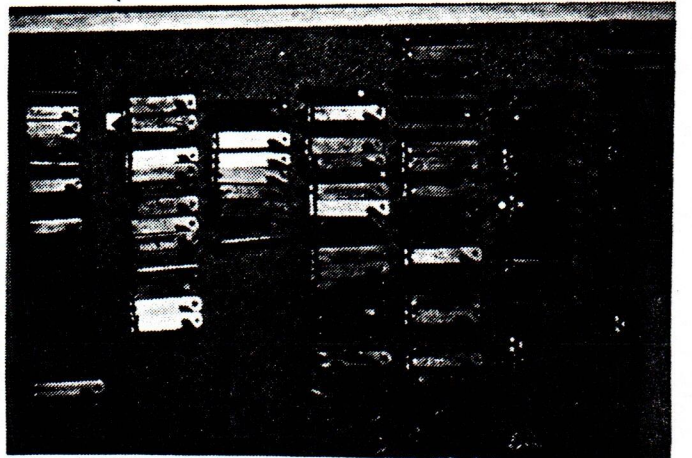
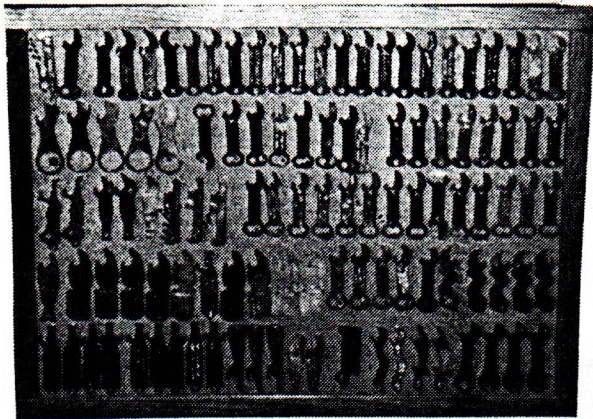
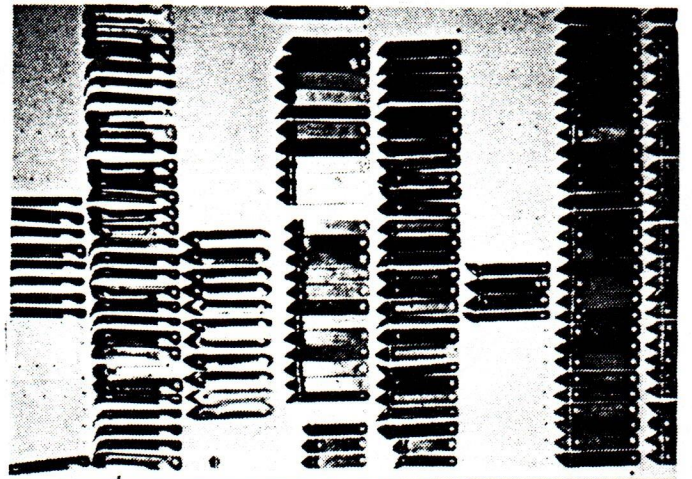
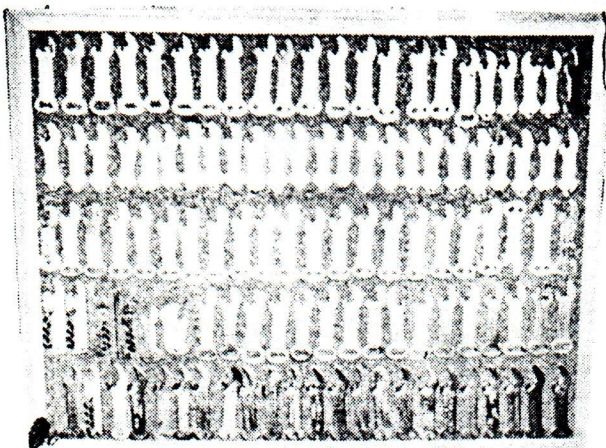
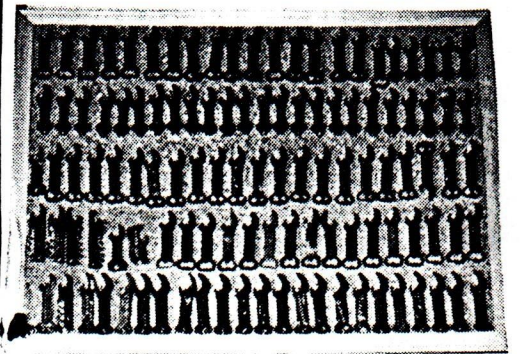
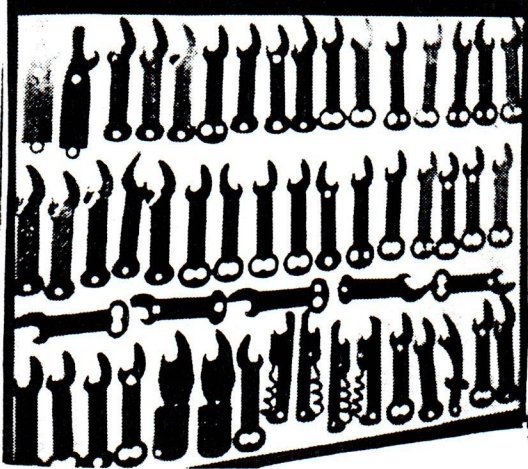
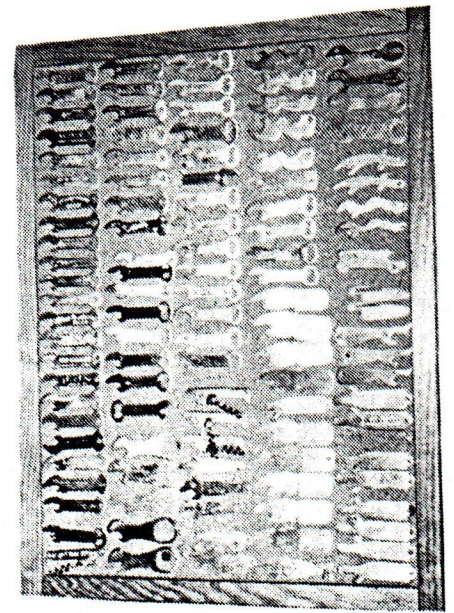
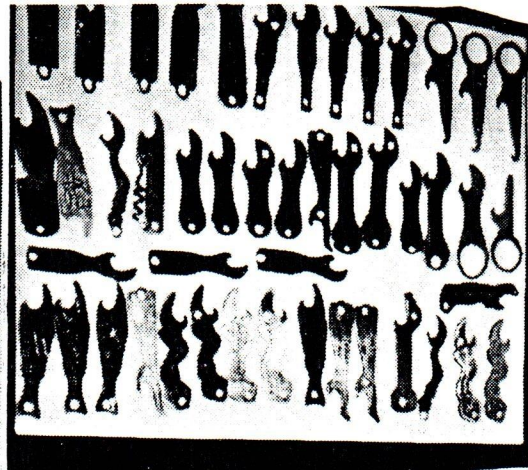
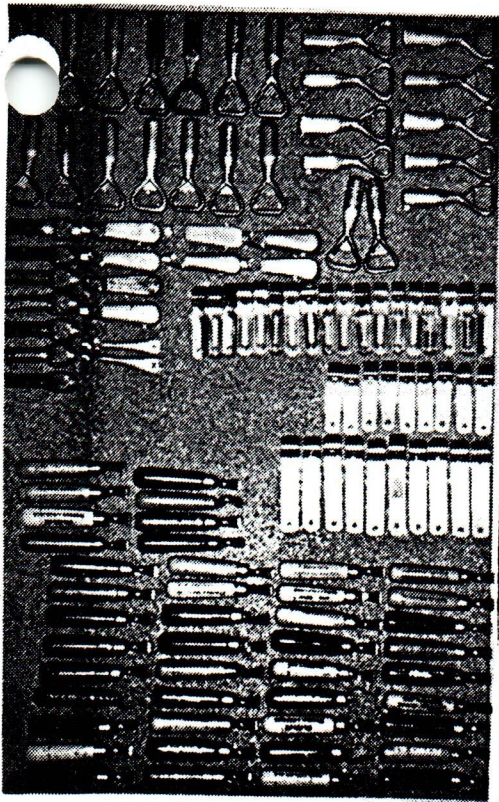

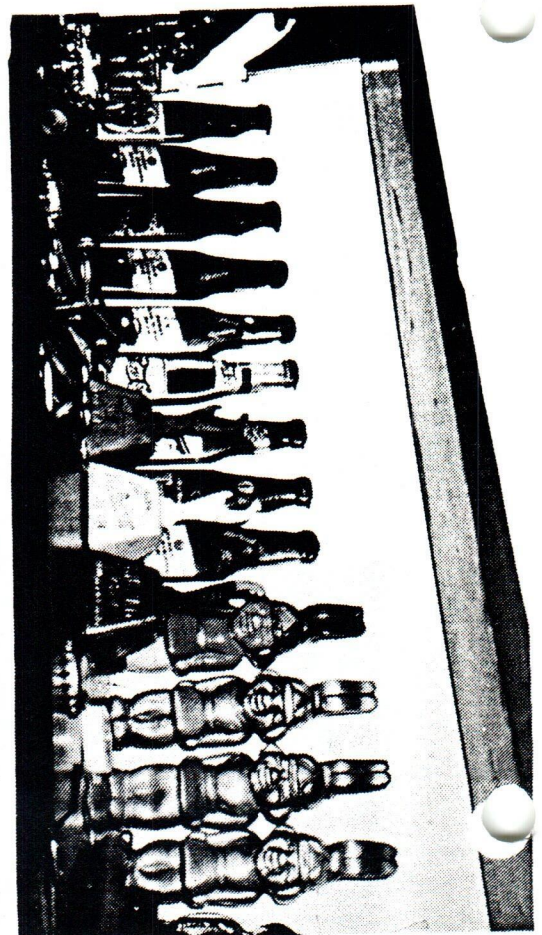
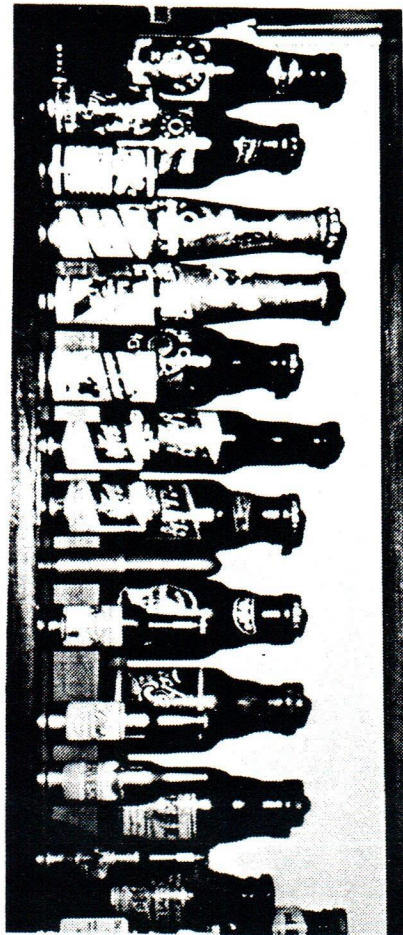
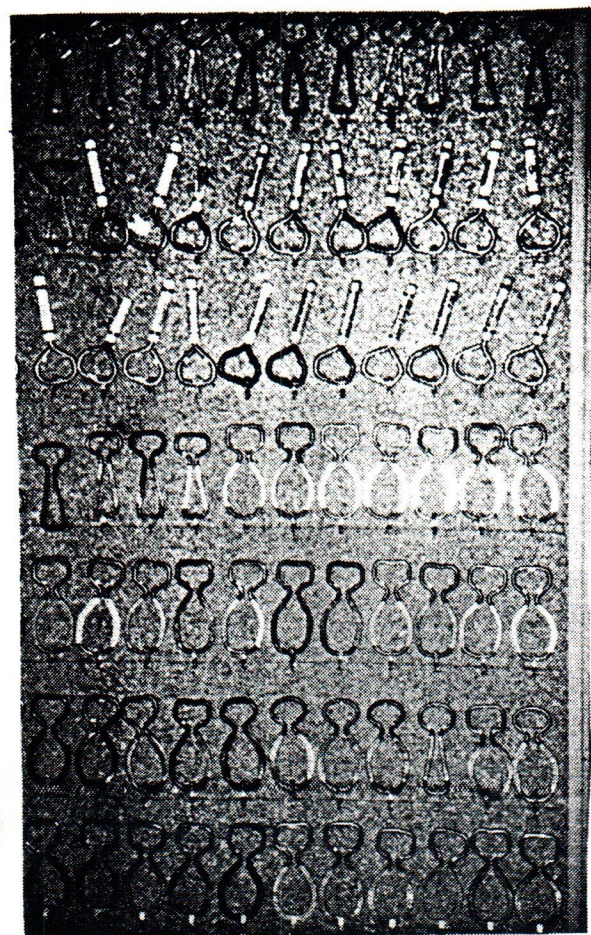
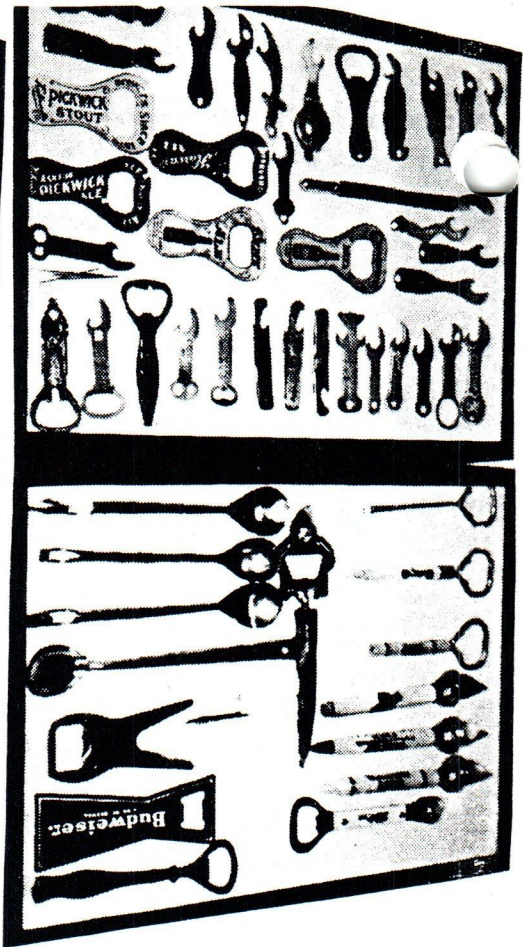
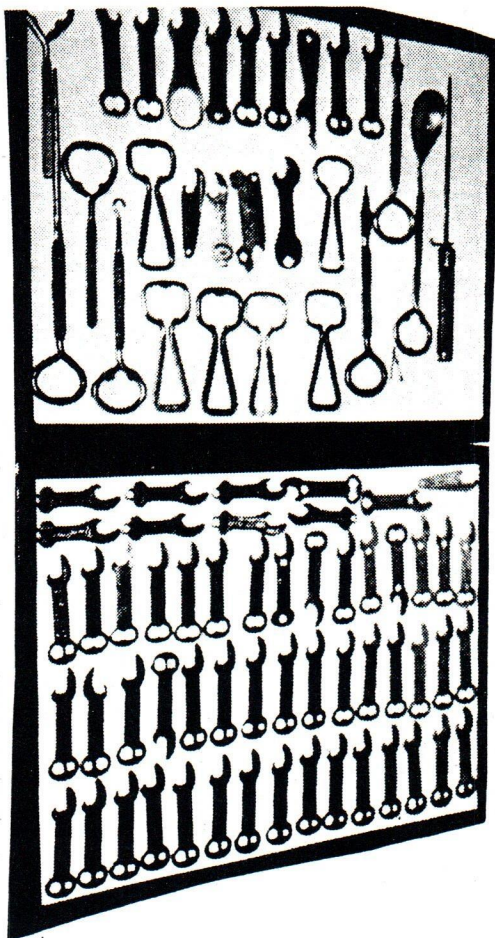
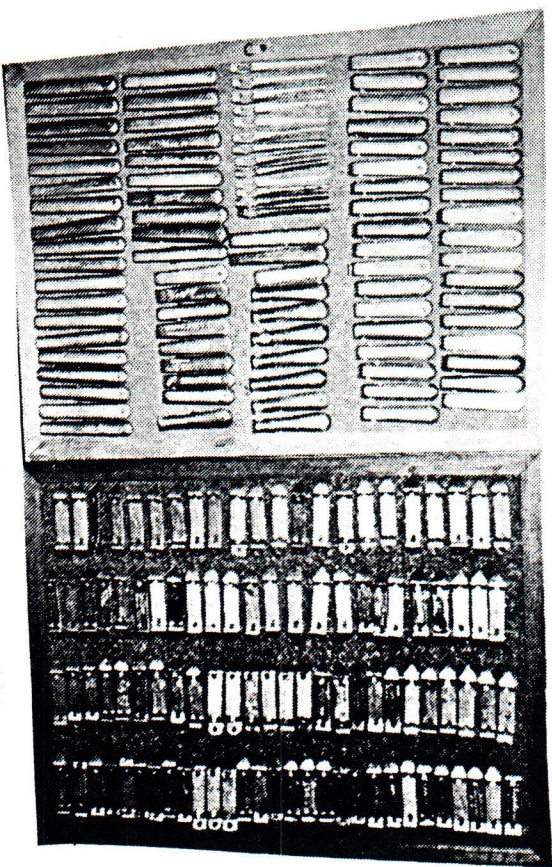

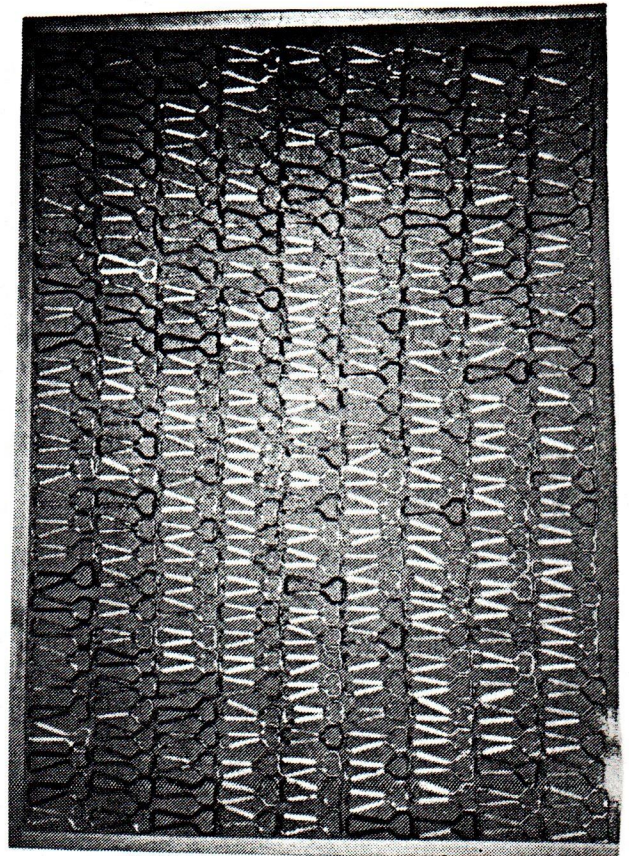
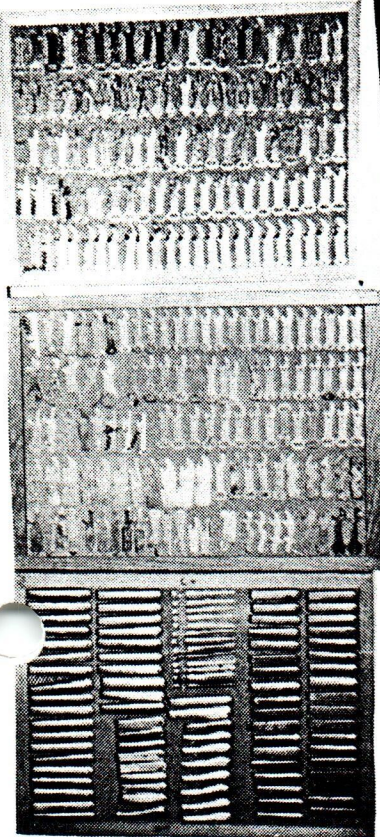
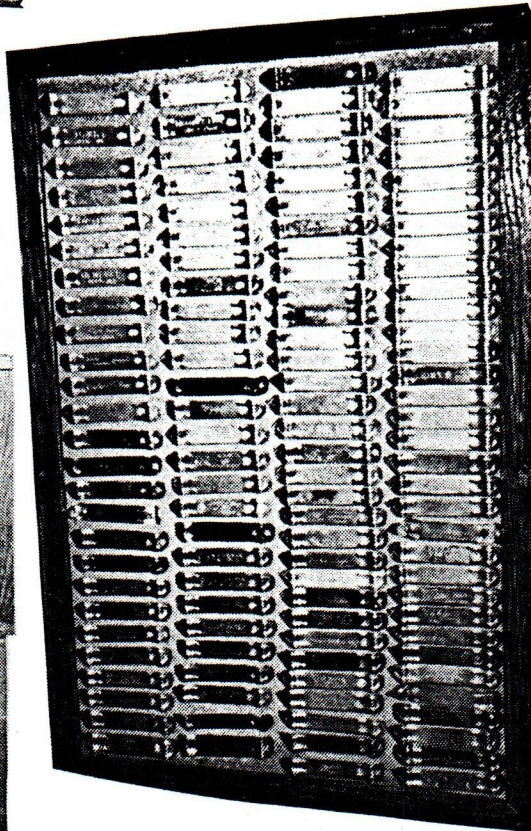
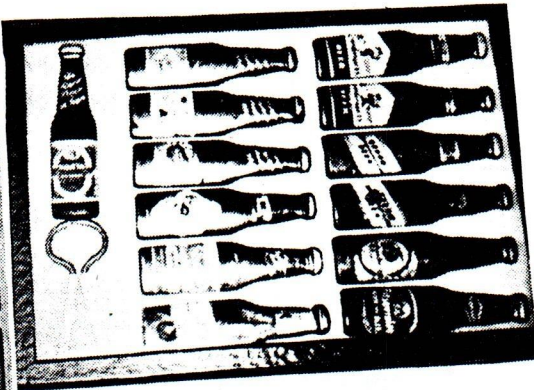
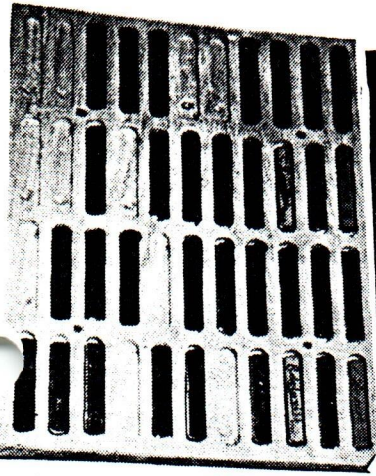
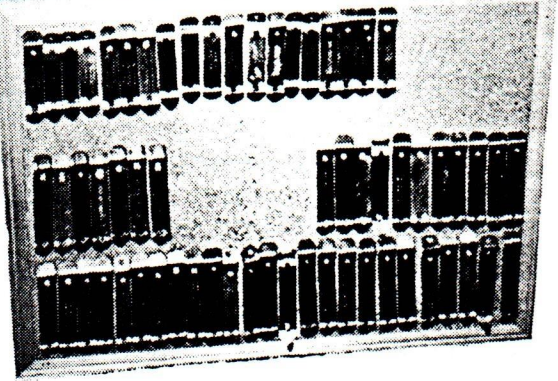
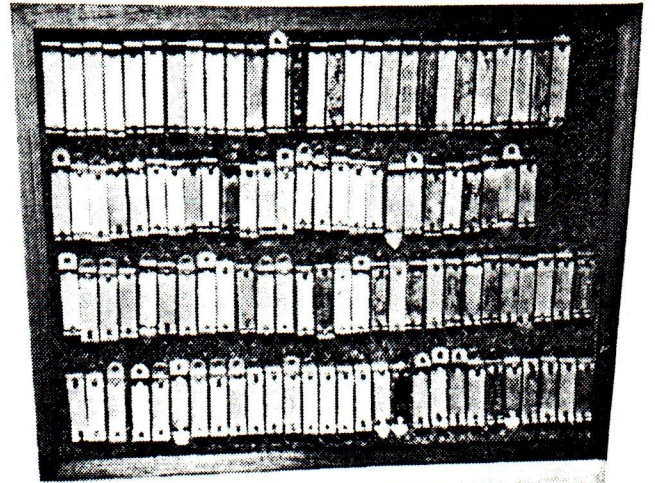
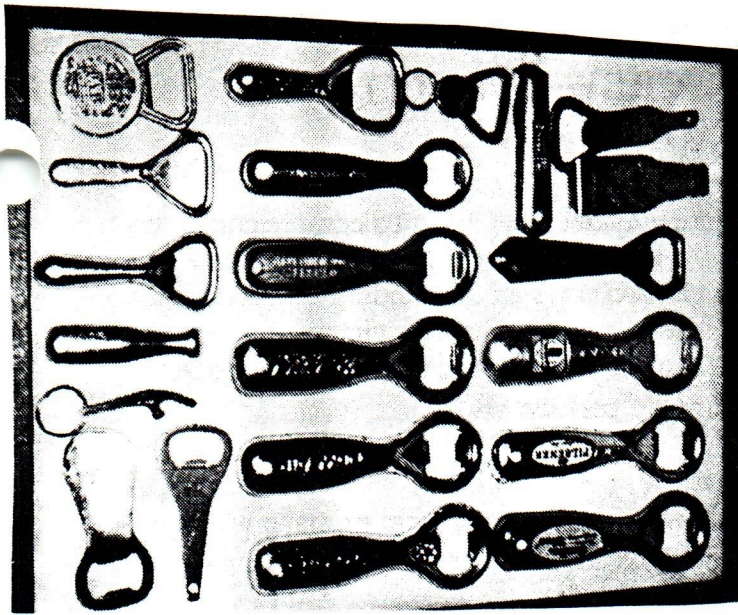

CCCC COOKBOOK FOR CORKSCREW COLLECTORS AVAILABLE NOW!

This year is the tenth anniversary of the Canadian Corkscrew Collectors Club. To commemorate this occasion, the members and their families co-operated by submitting their favourite recipes and a picture of a special corkscrew to be used as illustration. The project is an outstanding success! Some 39 members and/or their family members have submitted recipes and corkscrew pictures to swell the book to 200 pages. The book contains 10 different recipe classifications, about a 150 recipes, a gorgeous four colour front cover and many heretofore unseen corkscrews.

This book is a must for all collectors' libraries. Furthermore, there can be no better Christmas gift than this book. Give it to all your friends! Point out the recipes you want them to make when you are invited over (if ever) and the corkscrews they should be looking for when they think about presents for your birthday; Christmas; or what-have-you.

We printed 250 copies and, therefore, we can supply all your needs. Each copy cost the CCCC \$10.00 to print (printing costs only, no personal costs included). We are selling them for this amount as we want to have as many as possible given away. When you place your order, send a cheque equal to the number of copies you want times \$12.50 which includes the cost of shipping them to you. If you come and pick them up or use your own courier, shipper etc, the cost will be only \$10.00. If there are cheaper methods to ship, arrange for it, pay them and pay the CCCC only \$10.00 per copy.

Order one right away and see how wonderful a gift this will be, then go nuts and order for every friend you have! The CCCC will recover the majority of the costs but will be in the hole for about \$1,000.00, if and only if, you buy the books. If you don't, then we will be in a larger hole! Send your order to:

Joseph. C. Paradi
670 Meadow Wood Rd
Mississauga, Ontario, L5J 2S6, CANADA.

or, Fax it to 416-823-3775.

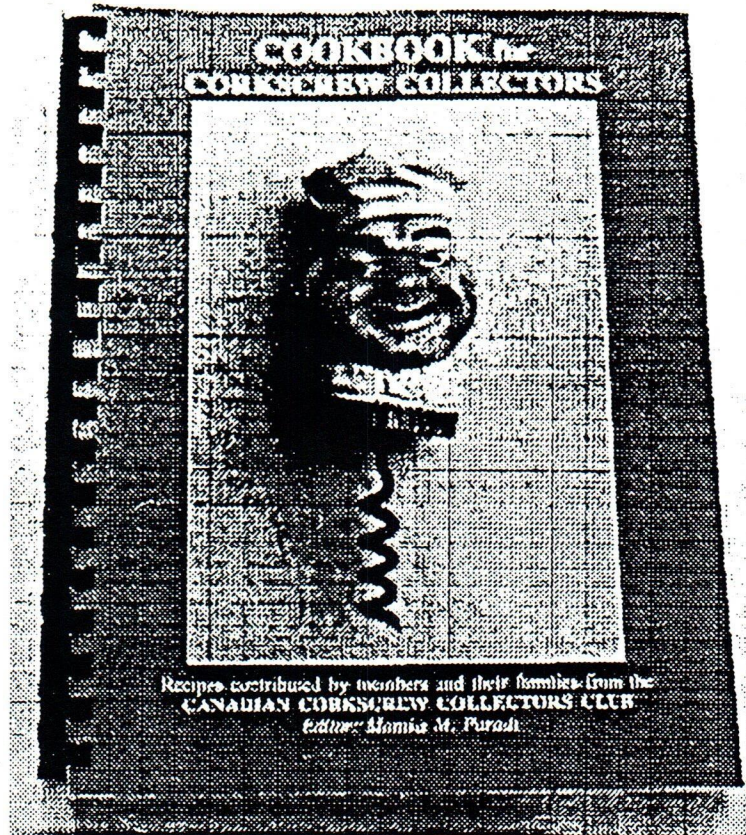

ED KAYE SEZS:

As promised in the Jan. issue, these are the members who contributed to the New Additions listings: Paul Wagner, Art Santen, Jack Ford, Verne Vollrath, Bob Van Vactor, John Stanley, Harold Queen, Harriet Waldo, Bill McKenzie, Carl Rees, Larry Biehl, Larry Moter, Brian Morin, Ben Hoffman, Ray Braeuner, Dave Pinney, Mike Kimmons and Bill Pattie. Their time and effort is appreciated by us all and I thank them sincerely.

With no excuses, I apologize to: Larry Biehl, John Stanley, Bill Pattie Alan Geyer and Joe Cardone who sent in more than one list which were misplaced but now located for next year's additions.

Comments:

Bill Pattie - your B-21 American Beer is #8.

B-23 Overland is #142.

Verne Vollrath - your B-18 Old Manhattan is not beer related.

B-18 National Beverage is #348 (Badger).

F-6 Smile Sirup is not beer related.

F-8 German Brewing is #8.

Jack Ford - your B-14 Drink Golden etc. is not #92. It is #139.

B-18 Golden/Cal Brewing is #469.

B-18 Kingsbury/Manitowoc is #45.

B-23 Lethbridge etc is not U.S.

H-6 Pabst is #5.

A-7 Pabst Specialty Shop etc. is not a beer per se.

If anyone has a question about an opener, I'll try to answer it in this column. For a quicker reply, send a current price stamp.

* SPECIAL NOTICE *

I have been doing the updates of the New Additions/ULs for the past 12 years. What aided me was the computer system I purchased in 1980 (before that, it was laid out and then typed). The system is on "its last legs" & I don't intend to purchase another one. So - I need someone to think about taking over this rewarding (personal satisfaction) task. Please let me know of your desire to do this for our specialized hobby and our ardent group of collectors. THANK YOU!!

PAINTED LABEL SODA BOTTLE AUCTION. If you collect or deal in any ACL sodas, here is your chance to acquire some better bottles. Auction lists will be sent March 1st, 1992. Prime opportunity for collectors or investors in antiques. Send for extensive listing. Soda Mart, 1055 Ridgecrest Drive, Goodlettsville, TN 37072. Phone (615)859-5236 Fax (615)859-5238.

PAINTED LABEL SODA BOTTLE AUCTION



If you collect or deal in Coca-Cola or any ACL sodas, here is your chance to acquire some better bottles.



Auction lists will be sent March 1st, 1992. Prime opportunity for collectors or investors in antiques. Send for extensive list-



ing. Soda Mart, 1055 Ridgecrest Drive, Goodlettsville, TN 37072. Phone (615)859-5236 Fax (615)859-5238.

OPENERS FOR SALE-POSTAGE ADDITIONAL
TOM CORIEL, PO BOX 3883, WICHITA KS. 67201

TYPE	BRAND OR BREWERY	CONDITION	COST
B-14-27	Hamm's	VG	\$ 5.00
B-18-21	Dick's	F	6.00
B-19-62	Dick Bros.	G	10.00
B-22-62	Peter Hand	G	10.00
B-33-01	Edelweiss	G	10.00
C-17-16	Monarch	F	2.00
D-03-12	Leisy's	G	8.00
E-03-50	Gipps	VG	10.00
E-04-28	Dick's	G	6.00
E-06-144	Monarch Brewing	G	5.00
E-10-174	Stag	VG	4.00
E-11-01	Atlas Brewing	G	6.00
E-12-29	Star Union Brewery	VG	6.00
E-13-09	Hamm's	G	4.00
E-14-223	Pilsen Brewing	G	4.00
G-08-18	Monarch	G	4.00
H-03-06	Edelweiss	G	4.00
I-04-12	Fox Deluxe	F	1.00
I-06-09	Canadian Ace	F	1.00
I-11-156	Van Merritt	VG	2.00
I-12-167	Stag	VG	2.00
I-13-07	Canadian Ace	G	3.00
I-14-41	Stag	F	1.00
I-17-39	Fox Deluxe	VG	3.00
I-22-18	Tavern Pale	F	2.00
J-04-02	Embassy Club	G	2.00
J-05-02	Atlas Prager	G	2.00
J-06-03	Atlas Prager	G	2.00
M-18-01	Budweiser	VG	12.00
50 Years of can openers		VG	1.00
1987 JFO Conv. Alsip, Il.		G	1.00



GARY'S ANTIQUES & COLLECTIBLES

A Group Shop
Breweriana
Advertising, Books
Glass — China
Depression — Etc.

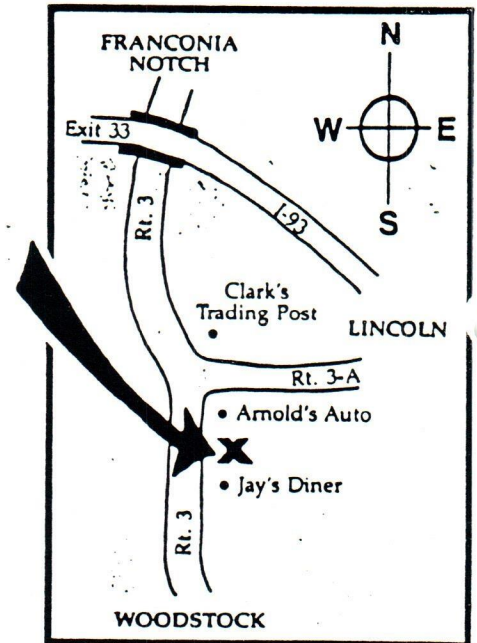

Hours: 10:00 a.m. to ??
Seven Days a Week

Rt. 3, PO Box 438
Lincoln, NH 03251-0438
(603) 745-2347 or (603) 745-8477

THE MUSEUM OF BEVERAGE CONTAINERS & ADVERTISING

Over 30,000 different beer & soda cans and over 10,000 soda bottles on display along with all types of unique beverage advertising. Also a 2,500 square foot Gift Shop. For more information write or call: Soda Mart \ Can World, 1055 Ridgcrest Dr., Goodlettsville, TN 37072, (615) 859-5236

They Treasure

"We're running out of walls," he said. "We may have to build a new house. A collector never stops. The curse of the collector is that after a while, the collection owns the collector — dominates his life!"

Chris Affolter ,KAREN
4450 Onyx Ave.
Klamath Falls, OR 97603
882-8053

Harold Arnold ,ANITA
P.O. Box 393
N. Lima, OH 44452
(216)549-9827

Kurt Bachmann
113 Wenonah Dr.
Pontiac, MI 48341

Mark Barren
6806 Bear Ridge
Lockport, NY 14094-9215
(716)625-8258

Tom Bates-Soda/Can World
192 Ridgecrest Dr.
Goodlettsville, TN 37202
(615)859-5236

Ronald J. Behnken ,JANICE
405 S. Brewer St.
Manchester, IA 52057
(319)927-2116

Marc Benjamin ,PAT
RFD 2 - 159 F
Edenton, NC 27932

Gerald J. Berghold ,MOLLY
327 Wlaker St.
Winchester, VA 22601
(703)667-9296

Larry Biehl ,FRAN
448 Crandon
Calumet City, IL 60409
(708)891-4269

Natalie Blakeman ,LLOYD
P.O. Box 8621
Incline Village, NV 89450
(916)546-3078

FRED BOLTON ,SUE
3015 CADENCIA ST
CARLSBAD, CA. 92009
(619)942-5765

RICHARD BOYER
12688 GROVE
WAUKEGAN, IL. 60085
(708)336-3852

Raymond Braeuner ,JERINE
1520 Horine Rd.
Festus, MO 63028
(314)937-6805

Dick Britton ,BONNIE
2902 Lacota
Waterford, MI 48328
(313)683-2134

Roma Brodeur ,ALINE
Box 443 Station R
Montreal, Que. H2S 3M2
Canada (514)270-8532

Donald Bromm ,IDA
Rt. 2 - Box 36
Tekamah, NE 68061
(402)374-1632

Wm. Brunner
8773 W. Mineral Pt. Rd.
Mt. Horeb, WI 53572
(608)798-2793

Richard Bueschel ,HELEN
414 N. Prospect Manor
Mt. Prospect, IL 60056

Don Bull ,BONNIE
20 Failway Drive
Stamford, CT 06903
(203)968-1925

Bud Burleson ,CHERYL
518 - 23rd St. SE
Salem, OR 97301
(503)378-0858

Joseph J. Cardone
1833 Rosemont Blvd.
Dayton, OH 45420
(513)254-6796

Alex Darocy KAREN
26 Oak Road
Santa Cruz, CA 95060
(408)423-4199

Michael Cargile SUSAN
20725 Shaker Blvd.
Shaker Hts. OH 44122
(216)371-8234

Don Davidshofer DAWN
1100 E. Taylor
Bloomington, IL 61701-5561
(309)827-5789

Brian Carlson
1849 E. Machanic
St. Paul, MN 55119-4820
(612)931-0889

Gary Deachman
Box 438
No. Woodstock, NH 03262
(603)745-2347

John Cartwright
4015 Waterhouse Rd.
Oakland, CA 94602

Dale I. Deckert
4087 Lake Conway Wood Bl.
Orlando, FL 32812
(407)859-1543

Jim Colwell
2404 Anise Dr.
El Paso, TX 79936-3504

Ron Defere, ANN
4513 Forest Hills Dr.
Two Rivers, WI 54241
(414)793-1382

Dr. Harry Counciller, CAROL
Box 66 East Main St.
Greensboro, IN 47344
(317)987-1282

Dave Derrick
1015 National St.
Vicksburg, MS 39180
(601)638-5543

David Cress
1816 Elizabeth St.
Janesville, WI 53545
(608)752-7262

John P. Donoghue
171 Lewis St. Lewis St. Ex
Lynn, MA 01902
(617)595-3499

Richard Creuziger
1226 Grove Ave.
Racine, WI 53405
(414)633-9245

Joseph A. Dubnicka, virginia
7024 East G Ave.
Kalamazoo, MI 49004
(616)345-3368

Robert D. "Red" Cross, FREDA
10851 N. 108th Dr.
Sun City, AZ 85351
(602)977-5397

Duane H. Dummer, CAROL
910 N. Palmatory St.
Horicon, WI 53032
(414)485-3395

Herbert K. Danziger, CAMILLE
550 Cherry Court
Birmingham, MI 48009
(313)646-9470

Rosale Emerson
1465 Willowbrook Dr.
Florissant, MO 63033
(314)838-1628

William J. Ennis
12220 14th Drive SE
Everett, WA 98208
(206)337-5068

John W. Goff, JAY
577 Brookhaven Ct.
Kirkwood, MO 63122
(314)966-3211

Lyle D. Feisel, DOROTHY
4 A Powderhouse Rd.
Binghamton, NY 13903
(607)723-4273

Stephanie Goldie
155 Normandy Court
San Carlos, CA 94070

J. Y. Ford
5351 Boyd Ave.
Oakland, CA 94618
(415)655-5393

Charlie Gooden, LINDA
25101 Watkinson Rd.
Acampo, CA 95220
(209)334-6733

Troy Fosnow
315 Garver Ave.
Rockford, IL 61102

Fil Graff, ROBBIE
704 Norwood Ct.
Naperville, IL 60540
(312)420-7735

Danny Freels
448 Essex
Clawson, MI 48017
(313)588-7297

Jean Gignon, C.A.
47, Chemin Du Theatre, C.P. 159
Eastman, Quebec, JOE IPO
Canada (514)297-3740

Frank J. Gach, MARY
8709 Allenswood Rd.
Randallstown, MD 21133
(301)655-1518

Edith D. Grisham
3520 Pinebluff
San Antonio, TX 78230
(512)691-0359

Chris Galloway, STAN
P.O. Box 11157
Pueblo, CO 81001
(719)544-9267

Donald L. Gross, CHRISTINA
716 Humbert Schoolhouse Rd.
Westminster, MD 21158-1239
(410)346-7021

Paul Gauvin, GAIL
24 Strawberry Lane
Manchester, CT 06040
(203)646-9722

Andy Growe
7337 Ethel, SP. 38
No. Hollywood, CA 91605

Alan Geyer, BETTY
5334 Huntingwood Ct.
Sarasota, FL 34235
(813)377-4536

Duane C. Gutterud
2509 N. Cambell #375
Tucson, AZ 85719

Richard Gilliland, PATRICIA
3920 Weyburn Dr.
Fort Worth, TX 76109-5036
(817)923-5580

Delbert Haarberg, BEVERLY
15562 El Capitan
Delhi, CA 95315-9708
(209)634-8096

Harvey Hansen, JO ANN
2906 - 39th St.
Two Rivers, WI 54241
(414)794-7026

John E. Horn, ARDEA
2828 Chestnut Lane
New Richmond, OH 45157
(513)553-3751

Arthur Hanson, MARGE
3028 Fiedmont Ave.
Duluth, MN 55811
(218)727-1172

A.L. Horstmeyer, JR.
94 Via La Cumbre
San Rafael, CA 94904
(415)461-1098

Russ Harding, JANE
870 Vindicator Dr.
Colorado Springs, CO 80919-3614
(719)599-3378

Terry L. Hufford, JAN
7147 Parkview Ave.
Falls Church, VA 22042
(703)573-1621

Herbert A. Haydock, HELEN
1660 2nd. Ave. South
Wis. Rapids, WI 54494
(715)423-8995

James Hupp, ANITA
6949 Hyde Park Dr.
San Diego, CA 92119
(619)460-6478

Ollie Hibbeler Jr. SHIRLEY
298 Highline Road
Lake Ozark, MO 65049
(314)365-3875

Larry Jaehnert
1697 Rose Ave. E.
St. Paul, MN 55106-2948
(612)776-9859

Jeffrey Hodge
P.O. Box 3119
Pomona, CA 91769
(714)621-2526

Carol T. Jantos, RUTH
7025 Kevin Dr.
Bethel Park, PA 15102
(412)833-4866

Benjamin Hoffman, CORNELIA
213 Simmons Road
Perkiomenville, PA 18074
(215)287-8243

Roger Jarrell, JANICE
1500 Sedwick Road
DURHAM, NC 27713
544-7787

George W. Hoffmann, MARY
Rt. 6 - Box 6554
Blairsville, GA 30512
(404)745-6819

Norman F. Jay, JUDY
839 James Ct.
Wheaton, IL 60197
(312)690-1565

Jim Hollinger
3395 Yankee Doodle #312
Eagan, MN 55121
(612)890-6835

Arthur F. Johnson, EILEEN
155 Hartford Ave. E
Mendon, MA 01756
(508)473-2780

Harry Horn, ROSE MARY
3113 Smoky Ct.
Sacramento, CA 95826
(916)362-3590

Arthur S. Johnson, JR., NANCY
347 East Orange St.
Lancaster, PA 17602

Odis Jones
2946 W. 7th St.
Jacksonville, FL 32205
695-0643

Victor R. Kroll, JACKIE
1550 Maple Ridge Rd.
Mosinee, WI 54455
(715)6933194

Ed Kaye , EILEEN
1478 Albatross Rd.
Sanibel Island, FL 33957
(813)472-0004

John E. Kutska
4334 Dubois Blvd.
Brookfield, IL 60513
(312)485-1961

Vic Keown , MARY ANN
10547 Mert
St. Ann, MO 63074
(314)428-6343

Arthur Landino , GRACE
88 Centerbrook Rd.
Hamden, CT 06518
(203)281-1085

Mike Kimmons , JANET
3801 Elledge Dr.
Shawnee Mission, KS 66205
(913)236-5441

Dick Lange , ELAINE
309 Orem St.
Mt. Shasta, CA 96067
(916)926-3684

Kenneth W. Klaassen
2412 East T Ave.
Klamazoo, MI 49002
(616)323-3192

ROGER H. LEVESQUE, CHRISTINE
1551 SULLIVAN AVE PO, BOX 826
SOUTH WINDSOR, CT. 06074
(203)644-9582

Bob Koch , MICKEY
1510 Ariana #450
Lakeland, FL 33803
(219)674-8554

Lyle E. Lewis , MARCY
22 Daviot Lane
Hiwasse, AR 72739
(501)855-4462

Harold L. Kogut , DOROTHY
7675 8st. N.
St. Petersburg, FL 33702
(813)522-3971

Samuel E. Lewis
3300 Penn Ave.
Pittsburgh, PA 15201
(412)683-8500

Donald L. Kohl
1000 W. Grand Ave.
Lima, OH 45801

William Link
RR-1 - Box-187
Kewanna, IN 46939
(219)946-4614

Lou Kovarik , ROSEMARY
12646 Alswell Ln.
St. Louis, MO 63128
(314)842-2446

George Lohmiller
2924 Orchard Ave.
Grand Junction, CO 81504
(303)243-3208

FRANK KRAFT, JUDY
1021 MULBERRY ST.
MANKATO, MN. 56001
(507)388-6042

Mike Loretta , BOBBIE
P.O. Box 28
Conifer, CO 80433
(303)838-4292

Jack E. Love ,DOROTHY
RR 2, Box 142, Hol. Manor
Elwood, IN 46036
(317)552-2369

Paul P. Luchsinger
104 Deer Run
Williamsville, NY 14221
(716)689-6580

Peter Lundell ,DONNA
35 Barbara Lane
Oakland, NJ 07436
(201)337-5767

Tom Lyons ,JANET
321 Valley Court Rd.
Lutherville, MD 21093
(301)296-0387

Ron MacLean
4201 Sunflower Dr.
Mississauga, Ont. L5L 2L4
Canada (416)820-0172

James Mahler ,CAROL
1819 Wood St.
Benton Harbor, MI 49022
(616)927-6635

Jerry Malia ,MARLENE
7491 Braymont
Mt. Morris, MI 48458
(313)686-7918

Peter J. Malloy
7820 E. Sweetwater
Scottsdale, AZ 85260
(602)991-6190

Phil Mandzuk
340 Morley Ave.
Winnipeg, MB. R3L OY5
Canada (204)452-1293

Doyle H. May
442 Sunset Blvd.
Hayward, CA 94541
(415)582-8311

W. DON MCINTYRE,PAT
P.O. BOX 52
FRIEND,NE.68359
(402)947-6551

Bill McKenzie ,ELVIRA
6360 So. Jellison St.
Littleton, CO 80123
(303)979-0987

Raymond Mellen,LINDA
11001 Seven Hills Dr.
Tujunga, CA 91042
(818)352-6409

Norma Mohr
11 Oak Valley Rd.
Bloomington, IL 61704
(309)829-6192

Brian Morin
24 Plymouth St.
Middletown, CT 06457

Larry Moter
Rt. 1 - Box 310
Woodford, VA 22560
(804)448-3928

Donald Mueller ,KAY C.
4649 Leona
St. Louis, MO 63116
(314)481-0384

Bill Muma ,SHERRON
8116 Rattan Way
Citrus Heights, CA 95621
(916)723-1461

Bill Nantt ,TARESA
1017 Pinot Noir
Lodi, CA 95240
(209)333-3719

Paul H. Neas ,ALMA
4953 Vera Cruz Road
Center Valley, PA 18034
(215)797-5759

Peter J. Nowicki
1531 - 39th Avenue
San Francisco, CA 94122
(415)566-7506

Bob Nugent , PEGGY
Rt. 1 - Box 169
Hillsboro, NH 03244
(603)464-3335

Dennis R. Orth
4210 S. Lake Five Dr.
Colgate, CI 53017
(414)628-3933

Steve Owen , CANDY
5409 Carmel Ct.
Tyler, TX 75703
(903)581-7458

Joseph C. Paradi , MONIKA
670 Meadow Wood Rd.
Mississauga, Ont. L5J 2S6
Canada (416)823-3754

Richard Patek, LEILA
Rt. 1, 10600 E. Ave. NW
Cedar Rapids, IA 52405
(319)396-2309

Bill Pattie , LYLE
37050 S.E. 89th
Snoqualmie, WA 98060
(206)888-2495

David H. Perkins
RR-1 - Box-5000
Brownville, ME 04414

Rodger D. Peters , BETTE
P.O. Box 401
Burney, CA 96013

R. C. Peterson , VAUGHN
1811 Brighton
Casper, WY 82609
(307)235-1063

John Povlinski, MARY
445 E. Ridge Rd.
Gary, IN 46409
(219)884-0948

Harold A. Queen, IDA
1001 Centre Ave.
Jim Thorpe, PA 18229

Michael Raposo, LEIGH
RR-2 - Box-120
West Huxton, ME 04093
(207)642-5004

Carl C. Rees , PAT
11366 N. Rio Vista Rd.
Pocatello, ID 83202
(208)237-2464

Charlie Reynolds , JUDY
2836 Monroe St.
Falls Church, VA 22042
(703)533-1322

Lehr Roe, JOAN
160 Penfield St.
Dundee, MI 48131
(313)529-2359

Robert Roger , REBECCA
8019 Steadman St.
Alexandria, VA 22309
()360-5737

Jon Ruckstuhl
P.O. Box 612164
Dallas, TX 75261
(817)354-0232

Arthur Santen, Dorothy
6126 McPherson
St. Louis, MO 63112

Jerry B. Schele , KATHLEEN
3744 Pineview Dr.
Fort Wayne, IN 46815
(219)483-6350

George Schiffers
882 Huron Ave.
San Francisco, CA 94112

Bob Stahly, MARGE
1508 E. Bridge St.
Streator, IL 61364
(815)672-4323

Conrad J. Schmitt, Jr., KAY
406 Eastbrook Lane
O'Fallon, MO 63366
(314)272-2814

John Stanley, PAT
605 Windsong Lane
Durham, NC 27713
(919)493-9802

TONY SCHNEIDER
11147 E. SUMMIT
LAOTTO, IN. 46763

Henry Stawarz, MARGE
RR 2 - Box 131
Rushville, IL 62681

Bill Sell
457 Holly Ave.
St. Paul, MN 55102
(612)227-9299

Larry Stevens
7003 St. Joe Rd.
Ft. Wayne, IN 46835

Lawrence C. Sherk
P.O. Box 191, Stn. G.
Toronto, Ont. M4M 3G7
Canada (416)465-3386

John Vanamerongen
2135 W. Webster
Chicago, IL 60647
(312)252-7819

Don K. Sherman, RUTH
438 Mavis Drive
Los Angeles, CA 90065
(213)225-7870

Robert Van Vactor
Route 1 - Box 3
Stanberry, MO 64489
(816)783-2245

Katheryn Sherrard
Star Route, Box 36
Ledger, MT 59456

Brad Vifquain
2401 NW 51st
Lincoln, NE 68524
(402)470-3779

Jack Shoffner, Jr., Dorothy
110 Ancilla Ln.
Ponte Vedra Beach, FL 32082

John I. Vlossak
1044 East Eldorado
Appleton, WI 54911

Henry M. Smith, LINDA
5459 Woodhaven Dr.
Cincinnati, OH 45248
(513)451-2641

Verne E. Vollrath, LAVERNE
218 S. Lexington Dr.
Janesville, WI 53545
(608)752-5708

Thomas E. Sorensen
106 S. Melvin St.
P.O. Box 94
Thawville, IL 60968

Ron Vyce
263 Simsbury Rd.
West Hartford, CT 06117
(203)233-8784

(217)387-2490

Paul H. Wagner ,STELLA
944 Hale St.
Pottstown, PA 19464
(215)326-5419

Scott J. Williams ,URSULA
11601 Tissel Hollow Rd.
Fairfax, Iowa 52228
(319)846-2919

Otto F. Wahl
14 Ogden St.
Glens Falls, NY 12801

Rod Wulff
623 Fern Way
Eldersvurg, MD 21784
(301)795-0771

Harriet Waldo
HCR-3, Box 1037
Rocky Mount, MO 65072
(314)392-3186

Joe Young, JACKIE
36 S. Weston Ave.
Elgin, IL 60123
(312)695-0108

Don Walker ,MARCIA
2294 Terrace Dr. N.
Clearwater, FL 34625
(813)799-4253

Anthony T. Zanghi ,CATHLEEN
2225 Deer Trail Rd.
Coopersburg, PA 18036
(215)346-8232

Lawrence D. Ward
118-D Lyellwood Pkwy.
Rochester, NY 14606
(716)426-2233

Terry Zieqler, RUTH
R.R. 1 - Box 481
Alburtis, PA 18011
(215)845-7102

Ted Warner
7566 E. Warren Dr. #16-304
Denver, CO 80231
(303)752-4217

Thomas A. Zurno
29 Eland Court
Fairfield, OH 45014
(513)874-7922

Frank P. Watkevich
306 Cottage St.
Athol, MA 01331

Donald D. Whelan ,CORA
1200 W. Maple St.
Savannah, MO 64485
(816)324-3603

Darwin Wilcox, ELLEN
8495 CROIX TR.
Rosco, IL 61073
(815)623-2255

Don Williams DIANE
1022 Diablo Rd.
Danville, CA 94526
(415)831-1783

1992 JFO CONVENTION PROGRAM

- APRIL 23: THURSDAY-REGISTRATION-HOSPITALITY ROOM
12:00 NOON. BREWERY TOUR HOSTED BY FIL GRAFF. LIMITED NUMBER OF RESERVATIONS AVAILABLE AT \$10.00 PER PERSON.
6:00 TIL ?. BUYING SELLING TRADING ROOM TO ROOM.
- APRIL 24: 11:00 AM LUNCH AT J.D. BREWS. EACH MEMBER ON THEIR OWN.
1:00 PM TOUR OF OLDENBURG BREWERY.
4:00 PM OPENER AUCTION IN THE HOSPITALITY ROOM.
6:30 PM GROUP DINNER IN GREAT HALL-ENTERTAINMENT-DANCING
- APRIL 25 8:00 AM SET UP (RAFFLE WILL BE CONDUCTED AT CONV.)
9:00 AM JFO CONVENTION (BUY-SELL-TRADE IN THE GREAT HALL)
3:00 PM CONVENTION ENDS (2:30 CLOSING CEREMONIES-AWARDS)

14TH ANNUAL
JFO CONVENTION REGISTRATION

THURSDAY-SATURDAY APRIL 23, 24, & 25, 1992

DRAWBRIDGE INN - OLDENBURG BREWERY
FORT MITCHELL, KENTUCKY

NAME _____

ADDRESS _____

CITY _____ STATE _____ ZIP _____

ARRIVAL DATE & TIME _____ DEPARTURE DATE _____

METHOD OF ARRIVAL _____ BY CAR ___ OR PLANE ___

ROOMS (RATES ARE \$41.00/SINGLE & \$51.00/DOUBLE) WILL BE IN THE GARISON WING. REGISTRATION IS \$35.00 PER MEMBER (INCLUDES WELCOME KIT, SHOW TABLE, HOSPITALITY ROOM, PRIZES, AND FRIDAY NIGHT DINNER WITH ENTERTAINMENT SHOW & DANCING IN THE GREAT HALL AT OLDENBURG). GUEST FEE IS \$25.00 WHICH INCLUDES FRIDAY NIGHT DINNER & SHOW. IF A MEMBER DOES NOT WISH TO ATTEND THE FRIDAY NIGHT SHOW & DINNER, THE REGISTRATION FEE IS \$30.00.

THE "BREWER'S MONK", FIL GRAFF, WILL CONDUCT A CINCINNATI BREWERY TOUR ON THURSDAY APRIL 23 IN THE AFTERNOON. COST FOR THE TOUR IS \$10.00 PER PERSON. WE MUST HAVE A MINIMUM OF 30 PEOPLE FOR THE TOUR. IN THE EVENT 30 PEOPLE DO NOT SIGN-UP, MONEY WILL BE REFUNDED.

NAMES FOR CONVENTION BADGES _____

PLEASE SEND REGISTRATION FEE, GUEST FEE, AND TOUR FEE IN ADVANCE
PLEASE MAKE CHECKS PAYABLE TO TOM ZRUNO
AN OLDENBURG CERAMIC MUG WILL BE GIVEN TO THE FIRST PERSON WHO REGISTERS

PLEASE REMEMBER
TO BRING A DISPLAY

RETURN TO: TOM ZRUNO
29 ELAND COURT
FAIRFIELD, OH 45014
(513) 874-7922