

Just For Openers Oct 2012-Jan 2013 Issue #136

Copyright 2013
 John Stanley
 PO Box 51008 Durham NC 27717
 (919) 824-3046
 Web Site:
www.just-for-openers.org

Past Editors
 Don Bull (1979-1983)
 Ed Kaye (1984-1988)
 Art Santen (1989-1993)

Annual Dues \$20.00 or
 View Free on the Web Site
 Use PayPal at jfo@mindspring.com
 Renewal Dues Dates: 9/30/12, 12/31/12
 Opener & Corkscrew Books
 (Details in Sale Ads & On Website)



P-63

P-63-1 Gerst Corkscrew/Opener

A fairly rare (4 or 5 known) corkscrew from Gerst Brewing of Nashville, Tn. The case comes in two colors, black and burgundy. The burgundy case is the easier color to find.



Collections

Besides selling Verne Vollrath's collection, I have also been selling the collection of former JFO member Marc Benjamin. He collected types and anyone interested in a list can email me at the above address.

JFO Newsletter Update Combining Issues

Besides being behind and to make it easier for your editor, the October and January issues and then for July the April and July JFO issues will be combined. It will also allow me to spend more time on the Just For Openers II book for 2013. Your comments are appreciated.

2013 JFO Convention #35 April 10-14 Holiday Inn Opryland Nashville TN

The convention is fast approaching and I have included a registration form for any last minute attendees. We have another nice group planning to attend. Nashville is a really fun town. Bring lots of openers and corkscrews for room-to-room trading and selling. Take the time to bring a display. Contest rules and convention details inside this issue.

Member's Update

Two more long time members passed away last year and both were from Sacramento, Ca. Harry Horn passed on April 29th at the age of 84. Harry was a general breweriana collector and loved openers from Sacramento and car shaped (JFO style A-13) openers. He attended the 1998 JFO Convention in San Francisco. John Fossette passed suddenly on October 5th at 73 years old. John mainly collected "A" type beer openers but had many high quality openers in other categories. He attended the 2004 JFO Convention in San Francisco. Our thoughts and prayers go out to Rosemary Horn and Mandie Fossette and their respective families. Two more great guys go to opener heaven.

35th Anniversary Salute to Original Members

Every five years original club members still active are listed from when Don Bull started JFO in 1978 (Membership numbers 1-20). One member passed away since the 30th list five years ago. It is a good time to also list members who were on board by the time Don issued the second edition of the Just For Openers newsletter. Those membership numbers go up to 200. Those names are also listed below. Thank you all for supporting Just For Openers for 35 years. Names shown with their membership numbers.

Don Bull 1	Alex Darocy 5	Duane Dummer 7	Jack Ford 8
Herb Haydock 13	Don Sherman 18	Bob Chapman 35	John Donoghue 40
Tom Lotheridge 62	Pete Nowicki 67	Gary Deachman 91	Glen Enloe 95
Jim Osborn 126	Rod Wulff 143	Art Santen 158	Verne Vollrath 162
Larry Sherk 175	Bob Stahly 176	Norm Jay 181	Craig Green 187

Just For Opener II a New Book by Don Bull and John Stanley

Schiffer Publishing contacted Don last fall and was curious if we would update the original Just For Openers book as they would have sold all 5,000 copies by sometime in 2014. At first we thought we could just do another book on all types and just add to the first book but I quickly realized that in the 1998 book we had about 900 types and we were now up 1,600. Many of these I did not own examples so Schiffer agreed for us to create a new book. For “A”s and “B”s we will show all types along with a few other categories but most of the others we will concentrate on older openers. Also when photographing types if I had many or all of the known examples they are included as a “set”.

The initial book proof is due to Schiffer by August 1st. One of the reason this newsletter is so late is because I spent most of December and January rounding up openers I knew I needed to borrow from JFO members. Just about everyone who was asked was able to help and in early February I spent three days at Don’s house shooting pictures. We took almost 2,000 pictures and have used about 1,250 so far. Below is a list of openers I would still like to get pictures of if anyone has a nice condition piece. Also we can use “Point of Purchase” items (original packaging and ads). If you have any of these openers or original packaging please contact your editor.

Just For Openers II (Items Needed-4 Openers) & Any “Point of Sale Ads or Go-Withs”
1) F-19 (Any US Beer Ad) 2) F-25 (Any US Beer Ad) 3) L-7 Ballantine 4) P-58 Rahr Malt

2013 JFO Convention #35 SCHEDULE April 10-14 Holiday Inn Opryland Nashville TN

Tuesday-Wednesday: Early Check-Ins Room-To-Room Trading
Thursday: Continued Checking In & Room-To-Room Trading
Friday: Possible Group Luncheon, Auction Late Afternoon (Hospitality Room)
Saturday: Public Show and Group Supper that Evening for People who Stay Over
Hospitality Room Location: Tennessee Room (2nd Floor)
Displays: Bring Something
“Bill McKenzie Best of Show Award”: Your one favorite piece
Regular Display Contest: 1st, 2nd & 3rd Places Awarded (Whatever you want to show)

2013 JFO Nashville Convention #35 Member’s Want List

A-009-046, Tivoli Denver, John Stanley	B-005-037, Moehn, Scott Williams	C-049-076, Anheuser World Lager, Art Santen	L-008-001, Hamms, Gary Deachman
A-013-012, Buffalo, John Cartwright	B-007-009, Pointer, Scott Williams	C-082-001, Budweiser (Crown), Art Santen	L-010-001, Alpen Brau, Jim Osborn
A-013-021, Blackhawk, Scott Williams	B-014-040, Salinas, John Cartwright	C-082-002, Budweiser (Eagle), Art Santen	L-013-001, Iroquois, Gary Deachman
A-013-029, Fredericksburg, John Stanley	B-014-102, Vinto Malt, Pat Stambaugh	E-004-100, Aetna, Tom Gormally	M-001-007, Kings Chremal, Jim Osborn
A-013-034, Fink, John Stanley	B-018-063, Pointer, Scott Williams	E-004-103, Balboa, John Cartwright	M-003-999, US Beer, Darvin Stilwell
A-015-046, Waverly, Scott Williams	B-018-175, Edel Brau, Scott Williams	E-004-248, Cambria, Tom Gormally	M-019-999, US Beer, Darvin Stilwell
A-015-071, Nulife, Scott Williams	B-018-256, Clinton, Scott Williams	E-004-300, Trainer, Tom Gormally	N-011-005, Rainier, John Cartwright
A-017-026, Moehn, Scott Williams	B-018-568, Pechstein & Nagel, Scott Williams	E-004-339, Apex, Tom Gormally	N-011-015, Rainier, John Cartwright
A-021-063, Schatz Brau, Pat Stambaugh	B-021-222, Bierbauers, Pat Stambaugh	E-005-036, Fitgers & Hamms, Pat Stambaugh	N-023-004, Falstaff, Mike Krejci
A-021-077, Ottos Lager, Pat Stambaugh	B-021-322, Blass, Pat Stambaugh	E-005-047, Bohemian, Pat Stambaugh	N-023-005, Anheuser-Busch, Mike Krejci
A-021-128, Hamms, Pat Stambaugh	B-021-370, Fitgers, Pat Stambaugh	E-005-098, Schmidts & Royal Bohemian, Pat Stambaugh	N-023-009, Iron City Beer, Mike Krejci
A-022-001, Ballantine, Jeb Burruss	B-022-144, Budweiser, Art Santen	E-006-213, Kips Bay, Tom Gormally	N-040-999, US Beer, Darvin Stilwell
A-026-002, Zetts, Gary Deachman	B-023-180, Liebotschaner, John Stanley	E-009-105, Sioux City, Tom Gormally	P-019-007, Rainier, John Cartwright
A-026-005, Lexington, Gary Deachman	B-031-008, Valley Brew, John Cartwright	E-014-590, Burgermeister, John Cartwright	P-079-001, Blatz or Loerzel, Jim Osborn
A-037-001, Hand, Jeb Burruss	B-055-036, Budweiser, Art Santen	E-014-706, Old Broadway, Tom Gormally	P-087-001, Magnolia, Jim Osborn
A-043-001, Lexington Dixie / Old Heidelberg, Gary Deachman	B-077-001, Rialto, Jim Osborn	E-014-729, Saltzman, Tom Gormally	P-100-001, Rainier, Jim Osborn
A-043-004, Lexington Dixie, Gary Deachman	C-001-001, Central, Gary Deachman	E-017-007, I S D (Interstate), John Stanley	P-111-001, Hamms, John Stanley
A-043-005, Bozeman, Gary Deachman	C-001-002, Doleger, John Stanley	F-009-024, Budweiser, Art Santen	P-114-001, Blatz, Jim Osborn
A-043-008, Masterbru, Gary Deachman	C-001-002, Doelger, Gary Deachman	F-027-007, Fresno, John Cartwright	P-196-001, Bergner & Engel, Jim Osborn
A-051-001, Blue Ribbon, Jim Osborn	C-001-005, Schreiber, Gary Deachman	G-104-001, Budweiser (Crown), Art Santen	P-198-001, Van Nostrand, Jim Osborn
A-057-001, Ben’s Busy Bee, Gary Deachman	C-001-007, Budweiser, Gary Deachman	K-999-999, US Beer, Darvin Stilwell	Z-999-999, Tiki Mugs, Herb Danziger
A-060-001, Narragansett, Jeb Burruss	C-001-008, Liberty, Gary Deachman	L-002-024, Maier, John Cartwright	Z-999-999, Corkscrews, Herb Danziger
A-080-002, Budweiser (Shirt 07), Art Santen	C-001-009, Meyer, Gary Deachman		Z-999-999, Corkscrews w/ Patent Info, Josef L’Africain
B-003-003, Reno, Gary Deachman	C-001-010, Eichler, Gary Deachman		Z-999-999, Corkscrews, Josef L’Africain
B-003-005, Rainier, Gary Deachman	C-008-002, Grain Belt, John Stanley		Z-999-999, Corkscrews Syroco, Josef L’Africain
	C-021-006, Grand Rapids, John Stanley		Z-999-999, Anything That Catches My Eye, Mike St Amand
	C-021-008, Tornberg, John Cartwright		

Spouse's Corner

By Pat Stanley, the Editor's Spouse

John did retire, right?
You thought the newsletter was in sight.
His efforts have been in another direction,
Helping members sell collections.
Then he and Don Bull were asked to publish another book,
And all their time that took.
Once again John asked his collector friends,
To him their very best openers send.
Then nerves on end that they get here ok,
Before he headed to Don's home one winter day.
Don has all the photography expertise,
To make the perfect picture of every piece.
Now more panic until the openers are all returned,
Until then, the night light burned.
Next was the annual Blue-Gray Show,
And traveling home while the winter winds blow.
John went back to work on March 1st,
But you don't need to fear the worse.
He is only working 11 hours a week,
So the newsletter he will finally tweak.
Now it's time to focus on JFO Convention,
You know I would not forget to Mention.
The Convention Opener is ready to make its debut,
And Display Awards are in the queue.
Collectors will come to the city of country singing,
And with them, their openers bringing.
Where there's a will, there's a way,
And we all have a will,
To be together in Nashville.

Hersey Car Show October 10th 2012 by John Stanley

After retirement I knew it was time for a trip some where so I combined a trip to see Ben and Cornelia Hoffman with a visit to see Boots Queen. As always I have a great time staying with Ben and Cornelia and we had a very good visit with Boots. Everyone was doing well and before I left Ben and I did complete a pretty big trade but we have to keep the details private because some of those "serious" collectors may be bugging us for some of the items that were swapped. I arrived on Sunday, we spent Monday going to see Boots and so Tuesday was an open day. Ben said let's hit the local antique malls and shops. We set out and eventually ended up in Hersey where in one mall there, one booth had a RUSTY R-8-1 Kaier's wall mount for only \$200 but it was really rusted. Another booth had the Harley-Davidson motorcycle spinner opener for \$685 and you could get 10% off. It looked nice but it was the first one I had seen where the screwdriver tip was beat up so it was a pass. I did end up buying a B-1-33 Finks at a decent price.

We had learned at one early mall that the Hersey Car Show was this week and they always have lots of antiques and collectibles for sale. After a late lunch we tried to get in but only dealers were allowed Tuesday. So back to Ben's house we went and it was actually the next morning when I asked Ben about the possible trade and we completed it. I left mid-morning for home and figured Hersey was somewhat on the way. I got there by 10:30 and got in. The show is HUGE with a lot of empty spots and I only stayed two hours and saw very few small non-car collectibles. I'll be darn if early on I see another supposedly rare Harley-Davidson motorcycle spinner opener. It was in a small riker mount with a Harley-Davidson service pin. There were two prices and being a little excited I honed in on the \$275 sticker but it was for the pin. The spinner opener was \$1,250! I did look at it and the owner said he would take less but we would have to "spin for" his price or a lower price. I laughed and kept on walking. A few years back I said it was an \$800-\$1000 opener but too many have turned up and now \$300-\$500 is the going rate but they can still bring up to \$750. I did take a picture of the \$1,250 opener. There is probably a crazy Harley collector somewhere who will pay that price or close to it. Picture shows opener and pin. I chuckled all the way back to Durham.



CASH ON DELIVERY (IN A PLAIN WHITE BAG) by Josef L'Africain

After multiple phone calls with the seller of the invisible U-Neek, we both determined that a postal COD might not be the best way to go...But, I couldn't simply let this cork puller languish at this guy's house. It was time to put a plan into action. I called Skip* and asked where exactly he lived. He had mentioned Virginia in a previous conversation, but not the exact town. He gave me the name of the town, and I told him that over the weekend, I would make a few phone calls, and perhaps someone would be able to do a different kind of COD. Instead of using the post office, we would deliver the cash to him, and complete the deal.

Who do I know in Virginia...? I mapped out the distances. Wirtz, VA? Three hours and four minutes of driving one way...Hm...Stanton, VA? One hour and 14 minutes of driving one way...Still too far...I perused the CCC mailing list, what other collectors might be in the area? What other corkscrew collector do I know that would be willing to drive countless miles to go antiquing?? I had just the person in mind (No, not Tommy).

I sent an email off seeing if there were any roadtrips in this particular individual's future. The email that came back was promising, explaining he would be heading to the DC Big Flea in the morning, and then heading towards Leesburg. Leesburg? That is only 35 minutes from Skip*. After working out the details, I set about calling Skip. No answer on his phone, and no possibility of leaving a voicemail.



Painter

This morning, after receiving news that the individual acting on my behalf, was on the road, and heading to his ultimate destination, I called again, and this time got Skip on the phone. He was reluctant to give his actual street address, and thought perhaps the deal could be done at a remote locale. I told him that my agent was on his way, and would be calling him. And, proceeded to forward Skip's phone number to special agent Orrin Painter**

After making contact, Agent Painter explained that he had cash in a white paper bag. The clandestine exchange was about to take

place. The money drop would be at a McDonalds, where Skip (and hopefully the U-Neek) would be waiting for Agent Painter. An hour or so later, I received confirmation that the deal was done. Agent Painter came away with the U-Neek unscathed, and as luck would have it, with a lead on a pair of ladies legs. In the end, Skip got his cash (on delivery), Agent Painter got a lead on a pair of ladies legs (and a happy meal), and the U-Neek will be put up for auction in April on the ICCAuction. Nice work Agent Painter! And, thanks Skip!

*name changed to protect the identity of the seller
 **name changed because it was just funnier this way.



Mr. Cash



U-Neek

Two I.N. Arment's American Patents for Combination Can Openers and Corkscrew 1880 and 1885

Joe Young

April 2012

Pictured are I.N. Arment's patents for openers for can and bottles.
Arment's first patent, #234,646 of November 23, 1880, incorporates
a fold away knife for cutting twine or wire,
a folding corkscrew, a large brush
and a can opener



(Model.)
I. N. ARMENT.
Opener for Cans and Bottles.
No. 234,646. Patented Nov. 23, 1880.

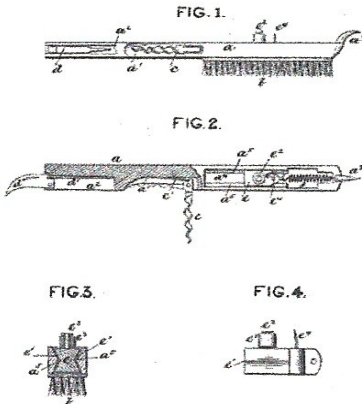

Witnesses
Wm. W. Lacey
W. H. H. H.

Inventor
Isaac Newton Arment
By *R. S. P. Lacey atty.*

Arment's second patent, Patent No. 327,923, (five years later) of October 13, 1885, shows considerable modifications. The brush is no longer present and there is an added second can opener for square or rectangular cans. And, as you can see, the corkscrew folds into the handle as in the first of Arment's patents.

(Model.)
I. N. ARMENT.
CAN OPENER.
No. 327,923. Patented Oct. 13, 1885.

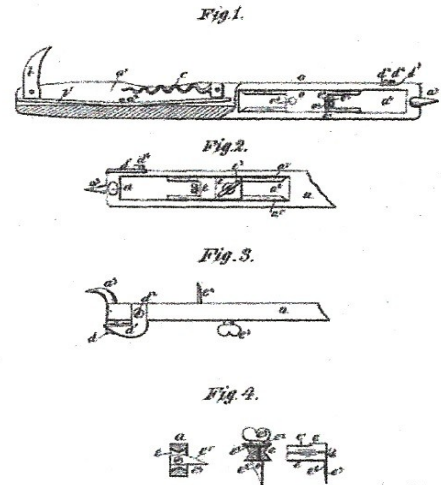

Witnesses
Geo. A. Duggan
Ch. D. D.

Inventor
Isaac N. Arment
By *R. S. P. Lacey atty.*

Our example (shown above) comes closest to the second patent with can openers for round and square cans. No longer present are the knife, the corkscrew or the brush. It is marked Pat. Nov. 23, 1880. It is very well made. However, I am disappointed that they didn't incorporate the corkscrew in the final production piece.



Sir Isaac Newton

The full name of the inventor is **Isaac Newton Arment**. His parents must have had great expectations for their son who was named after, arguably, the **greatest scientist of the 17th century - Isaac Newton**.

Until I found the patent for this piece, I didn't realize that the opener had such a distinguished pedigree.

Cleaning Using Electrolysis by John Eblen

As collectors, we all use various methods to clean and restore the openers we find that require it. Being a Starr X collector, I've come across many openers that were "brought back to life" after spending most of their life time in a wet or damp environment and left to rust. I discovered the best method to clean them was using electrolysis to remove the rust, paint and dirt accumulated over the years. A word of caution here is that using this method also removes paint and metal plating if the rust is very bad and has gotten beneath it. A good examination of the opener surface and plating should be done before hand in choosing the best method to clean and not to damage them further. Remember, the using of acids, strong chemicals, power wire wheels, buffers, or wire brushes, smears and damages the metal surface or plating on these openers and cannot be reversed after using them.

Parts List

The method is quite simple. Here's is a list of the items needed to clean by electrolysis:

1. 1/2 gallon plastic bucket or container
2. Anode (1/2" dia. stainless bar works the best)
3. Baking soda (Arm & Hammer)
4. Small battery charger (4-6 amp works best)
5. Water
6. Small pieces of copper wire
7. Brass wire brush



Directions

Place the anode in the bucket and fill with water. The anode needs to be long enough to stick up above the water line so you can clamp the + positive (**red**) battery charger lead to it and leaves enough space for the water to cover your piece. Stir in 1 heaping teaspoon of baking soda into the bucket with water, make sure to dissolve all of it. Using a piece of wood or metal, hang your piece with a piece of copper wire to allow the piece your cleaning to be completely submerged below the surface of the water. Now clamp the - negative (**black**) lead to the metal hanger or directly to the copper wire holding the part. Make sure the positive and negative leads or the pieces submerged never come into



contact with each other when the power is on. Never hook up and reverse the black or red leads as this will damage your part. Turn on (or plug in) the power to the battery charger. A setting of 4-6 amps of current works the best. Do not use a higher setting. Depending on the severity of rust present, a typical cleaning time is about 1 hour. Check on the part during this time period to insure you getting the results you want. Longer cleaning times may be required to remove all the rust deposits. Once your satisfied with the cleaning, remove the part and using the brass wire brush (brass does not scratch the surface), gently scrub the part, dipping the brush in the bucket water several times, to remove any other remaining surface staining you might see to bring out the luster of the plating. Flush the part with clean plain water to remove all traces of the baking soda solution and allow to dry.

Safety Tips: Always wear the proper safety equipment when using the above method. Caution should be used when connecting the battery charger up and never cross the leads or short-out (touch) the positive or negative together when the power is on.

Cleaning Using Electrolysis by John Eblen (Continued)

Here's a early Pepsi double dot that I cleaned up for my collection. Notice how rusty is was when I first received it. (before photo). After about an hour using the electrolysis method, I removed it from the bucket and used the brass wire brush to remove any remaining surface stains (after photo). A few places where I saw the plating was nicked up, before we started cleaning it, are now readily visible below the Pepsi name, but not bad.



The finished opener (right above) after the paint dried. Looks almost like new, results may vary.
 Other web-sites you can visit on using electrolysis cleaning:
http://www.rickswoodshopcreations.com/Miscellaneous/Rust_Removal.htm
http://www.stovebolt.com/techtips/rust/electrolytic_derusting.htm

In the last issue John's article on The Brown Manufacturing process, he asked if anyone could identify what vending machine the cap catcher shown in the picture went on? Unfortunately no one responded to me.

Guide to Collecting Brown Manufacturing Company Starr Bottle Openers Since 1925 By John Eblen

John's book is a superb history of Brown wall mounts with many historical facts added about the different companies that advertised using a Starr opener. John's research and correspondence with many collectors has allowed to date Starr openers and also he has included a rarity rating scale on each opener. Interested members can buy the book on Amazon at:

http://www.amazon.com/s/ref=nb_sb_noss?url=search-alias%3Dstripbooks&field-keywords=starr+bottle+openers

GUIDE TO COLLECTING BROWN MANUFACTURING COMPANY



By Harold J. Eblen Jr.

Larry Moter found this awesome ad from the Ryede Specialty Works that manufactured many G-5s and the G-19 (Folding Bottle Stopper/Screwdriver). Some rare brewery names.

Ryede Specialty Works

Rochester, N. Y.

Following is a partial list of the Brewers using our Crown openers and Combination Pullers.

- American Brewing Co.,
Buffalo, N. Y.
- Bartholomay Brewing Co.,
Rochester, N. Y.
- Bellingham Bay Brewery,
Bellingham, Wash.
- Claussen Brewing Association,
Seattle, Wash.
- Clinton Star Brewery,
Buffalo, N. Y.
- F. W. Cook Brewing Co.,
Evansville, Ind.
- Jos. Doelger's Sons,
New York, N. Y.
- Genesee Brewing Co.,
Rochester, N. Y.
- C. A. Koenig & Co.,
Auburn, N. Y.
- Liberty Brewing Co.,
Springfield, Mass.
- Lykens Brewing Co.,
Lykens, Pa.
- Moerbach Brewing Co.,
Rochester, N. Y.
- Mohawk Valley Brewing Co.,
Schenectady, N. Y.
- New England Brewing Co.,
Hartford, Conn.
- Port Hope Brewing and
Malting Co.,
Port Hope, Ont., Canada.
- Peter Schroeder Brewing Co.,
Perham, Minn.
- Washington Brewery Co.,
Washington, D. C.
- West End Brewing Co.,
Utica, N. Y.
- Windisch Muhlhauser Brew-
ing Co.,
Cincinnati, Ohio.

Ideal Crown Openers

Best in the World

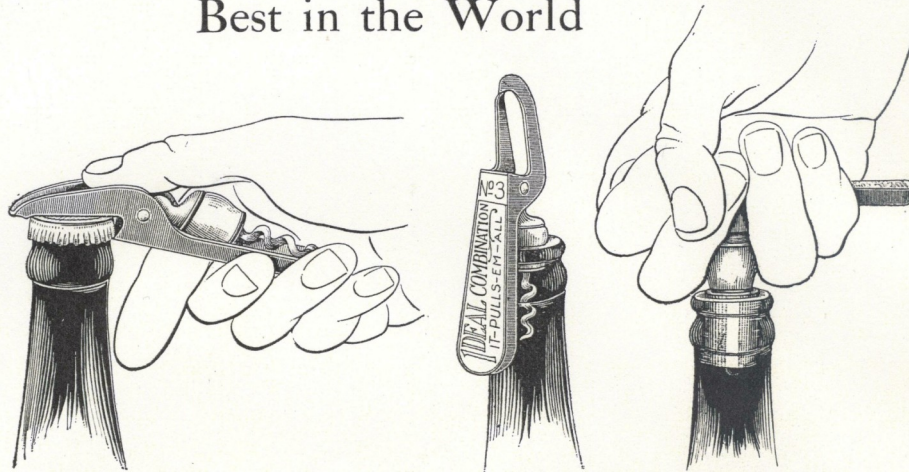

The Ideal Combination Number Three, a crown opener, a corkscrew and a stopper combined, contains all the tools necessary to unseal any bottle, as well as a stopper to be used where a bottle is sealed with a metal crown. Made from pressed steel, highly polished and nickel-plated.

A practical and durable article that makes an acceptable souvenir to the trade, as well as a unique advertising proposition.

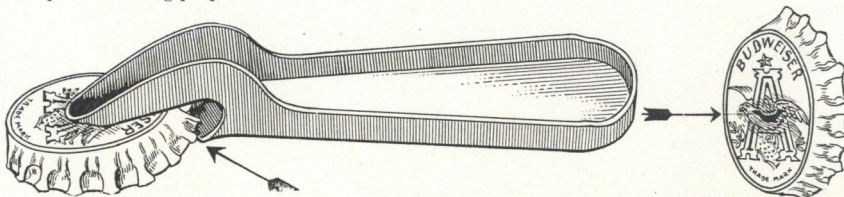

Ideal Number Four and a Half removes and destroys the crown in one operation without nicking the bottle, something no other opener can do.

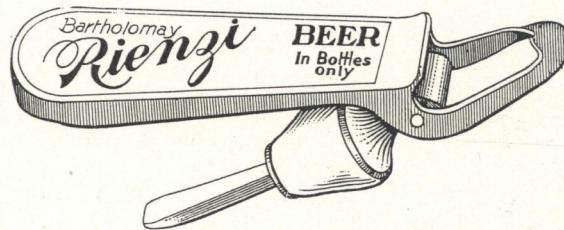

Ideal Number Five and a Half Combination Crown Opener and Crown Destroyer. Stopper for use after crown has been removed.

Ideal Number Four removes crowns quicker and easier than any opener on the market.

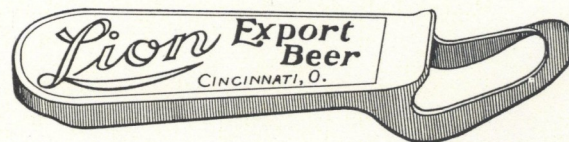

Write for samples and prices and let us prove the merits of Ideal Openers to you.

Designed, Patented and Manufactured by

RYEDE SPECIALTY WORKS

ROCHESTER, N. Y., U. S. A.

NEHI Leg Knives by Dennis Ellingsen

Dennis wrote an excellent article for Knife World in February, 2008 detailing how to tell a real Nehi leg knife from a reproduction. Below are some of the key pictures from the article. Thanks to Jack Ford for telling me about the write-up. Very few sellers ever admit they are selling the reproduction knife and almost all are the new ones.

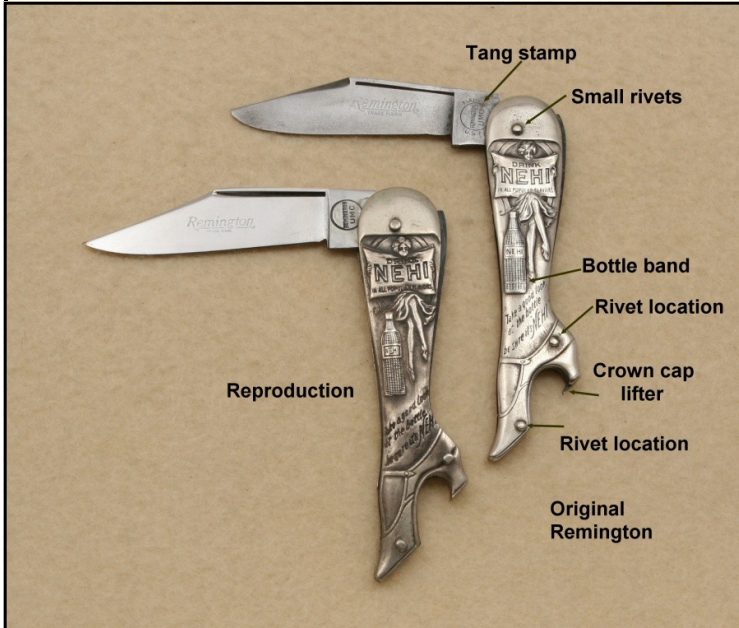

Dennis's article had several pictures and I am showing these four. Above are a reproduction and original side by side. Above right is the easiest way to identify an original by the protrusion of the cap lifter hook. All repros have the opener hook flush with the handle. Photo at right shows five different Nehi knives and all are reproductions. Below is a 1982 ad for the reproductions "by the boatloads" for \$4 each and you could buy in quantity for \$3 each. A 1929 Nehi ad first shows the original Nehi Remington knife and by 1930 a Remington catalog shows the knife pattern as being discontinued. So the original was a short run and explains why it is so hard to find.



Thank you Dennis for finally explaining an easy way to tell if the Nehi knife is a reproduction. He is a member of the Oregon Knife Club and Knife World Newsletter offers many good articles on old knives.

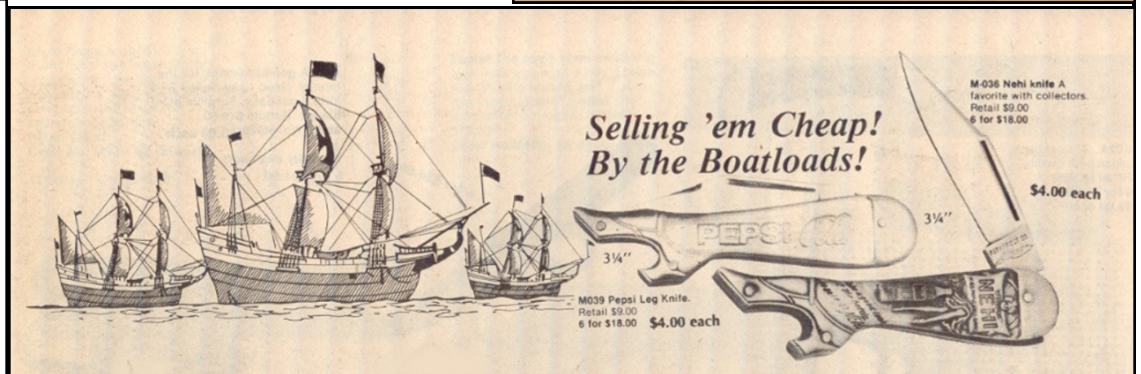

New Discoveries 2012

A-111



A-112



A-113



A-115



A-114



A-116



A-117



A-118



A-119



A-120

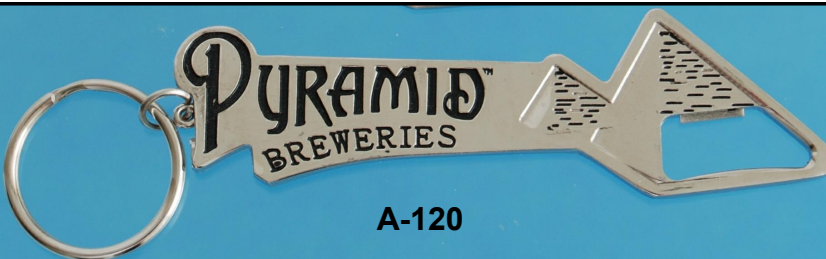

New Discoveries 2012 (Continued)



A-121



A-122



A-125



A-124

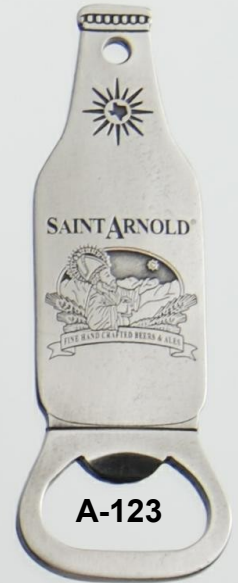

A-123

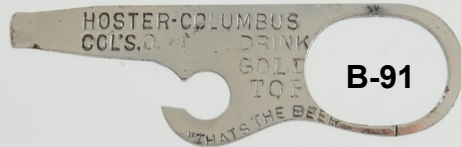

B-91



C-102

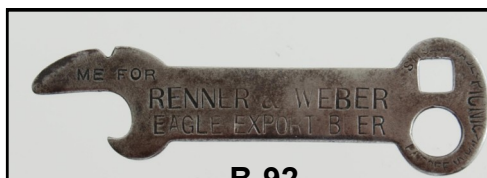

B-92



C-103



C-104

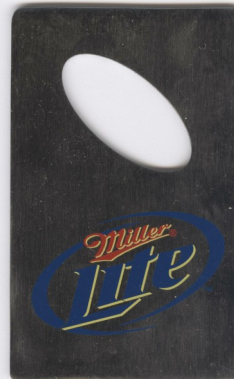

C-105

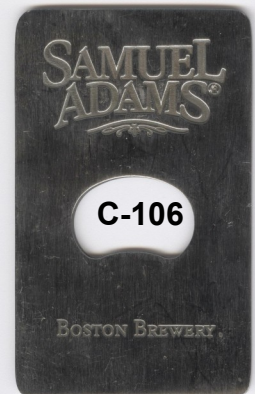

C-106



B-93

New Discoveries 2012 (Continued)

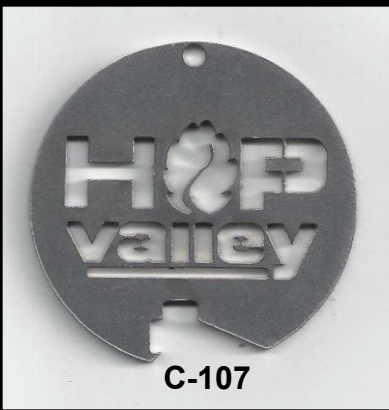

New Discoveries 2012 (Continued)



G-167



G-168



G-169



G-170



G-171



G-172



G-173



G-174



G-175



J-14



J-14



K-16

New Discoveries 2012 (Continued)



L-22



M-183



M-184

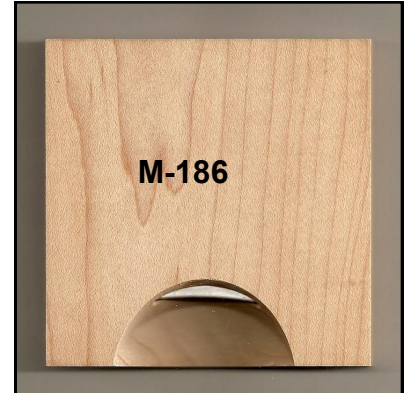

M-186



M-185



M-187



N-187



N-188



N-191



N-189



N-190

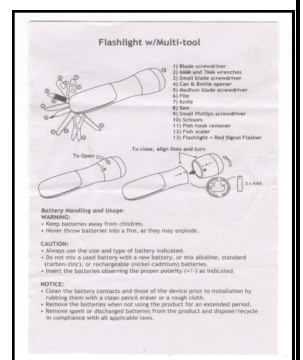

Flashlight w/Multi-tool

1) Blade screwdriver
 2) Small Phillips screwdriver
 3) Small flat screwdriver
 4) Can opener
 5) Nail
 6) Pliers
 7) Saw
 8) Small Phillips screwdriver
 9) Pry bar
 10) Small flat screwdriver
 11) Flat hook remover
 12) Flat-head and signal flasher
 13) Nail driver

To Open: Turn the flashlight on and the multi-tool will pop out.
 To Close: Flip the flashlight off and the multi-tool will retract.

Battery Handling and Usage
 WARNING:
 • Keep batteries away from children.
 • Never throw batteries into a fire, as they may explode.

CAUTION:
 • Always use the size and type of battery indicated.
 • Do not mix a used battery with a new battery, or mix alkaline, standard (carbon-zinc), or rechargeable (nickel-cadmium) batteries.
 • Insert the batteries observing the proper polarity (+/-) as indicated.

NOTICE:
 • Clean the battery contacts and those of the device prior to installation by rubbing them with a clean, moist tissue or a rough cloth.
 • Remove the batteries when not using the product for an extended period.
 • Remove spent or depleted batteries from the product and dispose/recycle in compliance with all applicable laws.

New Discoveries 2012 (Continued)



N-192



N-193

PIZZA CUTTER with BOTTLE OPENER

- Removable blade for easy cleaning: simply pull apart to separate
- Dishwasher safe
- Not for use on hot surfaces
- Easily cuts through pizza crust, brownies, sandwiches, and much much more!

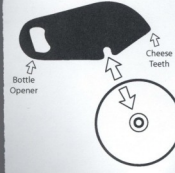

N-194



N-195



P-205



P-206



O-30

Q-124



Q-125

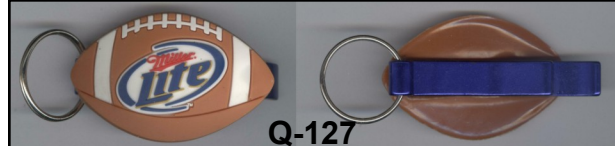

Q-127



P-207



Q-126



Q-128

New Discoveries 2012 (Continued)



R-98



R-99



R-101



R-100



R-102

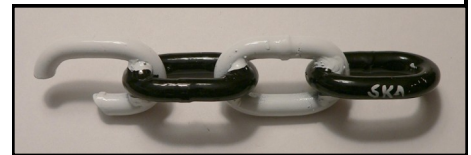

R-103

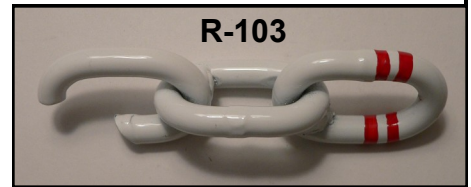

R-104



R-105



R-108



R-107



R-106



X-23

**JANUARY 2013 ADDITIONS & CORRECTIONS TO 2012 HANDBOOK
(COPYRIGHT JANUARY 2013 JOHN STANLEY)**

- A-1
- 125. BROADWAY MALT & SUPPLY CO. 1009 BROADWAY TEL. M-7348 SAN DIEGO, CAL.
A-3
- 65. JIFFY BRUMALT DISTRIBUTORS THE ALABAMA MERC. CO. BIRMINGHAM, ALA.
A-4
- 74. DRINK DUERLER BREW IN BOTTLES
- 75. "HOSTER'S FOR HEALTH PHONE PHILIP AUSTGEN AKRON, O."
- 76. RAHR'S THE BEER THAT MAKES MILWAUKEE JEALOUS
A-13
- 36. "HERE'S HOW" BEN E. MEYER, THE BUDWEISER MAN.
A-17
- 54. BIEWER'S BREWERY BREWERS OF THE ONLY BEER IN TOWN MT. CLEMENS, MICH.
A-20
- 57. TRU-BLU BEER
A-21
- 169. SPIN AROUND FOR BECKER'S BEST BEER OLD FAITHFUL BEVERAGE CO. IDAHO FALLS, ID.
- 170. PALM GARDEN JOE BROCK, PROP. COUNTRY CLUB BEER ON TAP KEARNEY, NEBR.
- 171. KEELEY HALF & HALF BEER ROCK RIVER DIST. 1611-15 SEMINARY ROCKFORD, ILL.
- 172. KRUEGER ALE HAMM'S BEER
A-21 CORRECTIONS
- 82. BLUE RIBBON FALSTAFF BEER BLACK HILLS BEVERAGE CO. DEADWOOD RAPID CITY (ADD 'BEER' 2013,1063)
A-29 CORRECTIONS
- 126. YOUNG & HOFFMANN TRI-MALT & HOP, SYRUPS NORWOOD 5753 (HOFFMANN HAS 2 N'S) (2013,261)
A-42
- 29. DRINK VA. BREWING CO'S. PURE BEERS, ROANOKE, VA.
A-52
- 10. BLUE RIBBON MALT EXTRACT OWNERS NO 836 3068 KENSINGTON AVE.
A-58
- 17. C C A C GLEN FALLS NY (COOPERS CAVE ALE COMPANY) (BLACK ON SILVER) (WHITE ON BLACK)
A-75
- 6. MILLER GENUINE DRAFT
A-81
- 5. PIZZA PORT (WHITE ON BLUE) (CARLSBAD, SOLANA BEACH CA MICRO)
A-111 SUPER BOWL TROPHY
CAP LIFTER
2 3/4"
JOHN STANLEY
- 1. BUD (C LOGO) LIGHT (NFL LOGO) SUPER BOWL XLVI
A-112 BOWTIE
CAP LIFTER
5 7/8"
JOHN STANLEY
- 1. BUDWEISER (WHITE ON RED)
A-113 COASTER
CAP LIFTER
3 5/8"
MIKE KREJCI/ART SANTEN
- 1. (C LOGO) BUD LIGHT (WHITE ON BLUE)
- 2. BUDWEISER (IN CROWN BOWTIE LOGO) GRAB SOME BUDS (WHITE ON RED)
A-114 BOTTLE
CAP LIFTER
7 1/8" JOHN STANLEY
- 1. COORS LIGHT (UNDER MOUNTAIN LOGO) (MOUNTAIN LOGO) SPECIAL EDITION / COLD AS THE ROCKIES (SIGNATURE OF) PETE COORS GREAT BEER (BOTTLE) GREAT RESPONSIBILITY @2012 COORS BREWING COMPANY, GOLDEN, CO

- A-115 STATE OF NEW JERSEY/BOTTLE
CAP LIFTER
3 1/2"
BEN HOFFMAN/MIKE KREJCI
- 1. COORS LIGHT (UNDER MOUNTAIN LOGO) NJ'S #1 BEER BOTTLES CANS
A-116 SURFBOARD
CAP LIFTER
3"
JOHN STANLEY
- 1. COORS LIGHT (UNDER MOUNTAIN LOGO) / SAME (BLACK ON WHITE)
A-117 CHAMPAGNE GLASS
CAP LIFTER
2 3/4"
LARRY MOTER
- 1. HARDYWOOD PARK CRAFT BREWERY (PIC OF TREE) RICHMOND, VIRGINIA / SAME
A-118 HAND
CAP LIFTER
3 7/8"
TODD BARNES
- 1. LEFT HAND BREWING COMPANY LONGMONT, COLORADO
A-119 SHARK
CAP LIFTER/MAGNET ON BACK
MADE IN CHINA BY WWW.GETAGADGET.COM
5"
BRIAN COOLEY
- 1. LOST COAST BREWERY EUREKA CALIFORNIA KILLER BEER!
A-120 ROAD TO THE PYRAMIDS
CAP LIFTER
4"
JOHN CARTWRIGHT
- 1. PYRAMID BREWERIES
A-121 HOP LEAVES AND PANTS
CAP LIFTER
3 5/8"
JOHN STANLEY
- 1. SHORTS BREWING CO. / SHORTS BREWING CO. LIFE IS SHORT WWW.SHORTSBREWING.COM
A-122 GUITAR
CAP LIFTER
3 3/8"
JOHN CARTWRIGHT
- 1. SLO BREW (GUITAR LOGO) SINCE 1988 (WHITE ON BLACK) (WHITE ON BLUE) (WHITE ON GREEN) (WHITE ON RED)
A-123 BOTTLE
CAP LIFTER
3 5/8"
JOHN STANLEY
- 1. SAINT ARNOLD (PIC OF SAINT) FINE CRAFTED BEERS & ALES (OM BODY) (PIC OF TEXAS LOGO) (ON NECK LABEL) / MADE IN CANADA
A-124 TROUT
CAP LIFTER
6 5/8"
JOHN STANLEY
- 1. SWEETWATER BREWING COMPANY / SAME
A-125 ARM AND HAND
CAP LIFTER
5"
JOHN STANLEY
- 1. TWO ROADS 2 BREWING COMPANY (PIC OF TWO POINTING HANDS) TAKE THE ROAD LESS TRAVELED / TWO ROADS 2 BREWING COMPANY (PIC OF TWO POINTING HANDS) STRATFORD, CONNECTICUT
B-5
- 61. DRINK SCHILTZ BOTTLE BEER D. E. SCHWEYER RIVERSIDE BOTTLING WORKS / MANUFACTURED BY NATIONAL SELLING CO. ALLENTOWN, PA.

- B-13
153. DRINK A*B*C* BEER / AZTEC BREWING CO. TIJUANA - MEXICALI. MEXICO
154. RELIABLE MALT & HOP CO. 6155 GRATIOT MELROSE 3826 / MALT, HOPS & SUPPLIES H. M. LATIMER
- B-14
205. HOSTER DRINK BRUIN A CEREAL BEVERAGE / COLUMBUS OHIO TRY HOS=COLO A COLA BEVERAGE
- B-17
17. CALL FOR EVANSVILLE BREWING ASS'N BEERS STERLING, RHEINGOLD, PALE EXPORT
- B-18
741. COMPLIMENTS OF GEO. C. FRANK, "HOSTER BEER" NORFOLK, VA.
742. DRINK "RHEIN GOLD" TONOWANDA BREWING CO.
743. JOHN WALTER BREWING CO. EAU CLAIRE, WIS. / DRINK OUR FAMILY BEER
- B-18 CORRECTIONS
371. MOERLBACH HEIM BRAU BANQUET BREW (CHANGE BEER TO BREW) (2013,261)
- B-19
282. THE JOHN HAUCK BRG. CO. 435 DAYTON ST. CINCINNATI, O. U.S.A.
283. MARIAN WLECZOREK HORLACHER'S BEVERAGES, PHONE 328-P, 734 E 4TH ST.
- B-21
642. AGENT OF VAL. BLATZ BEER J. BAUGHFMAN ABERDEEN, WASH
643. DRINK DIETADE MINERAL WATER I. MERKEL & SON PLATTSBURGH, N. Y. (BOTTLED SCHLITZ SEE G-5-37)
644. KEY TO METZ BROS. BR'G. CO. OMAHA'S FAVORITE BEER
- B-23
203. PABST BLUE RIBBON MALT SYRUP / HOME BREW MALT EXTRACT CO. 3489 MISSION ST. S. F. PHONE VALENCIA 2248
- B-36
11. SOLE DISTRIBUTORS OF PURITAN MALT EXTRACT & HOPS / J. W. HUNTER 919 D. STREET N. W. WASHINGTON D. C.
- B-73
142. APPALACHIAN BREWING COMPANY (BRIDGE OVER RIVER LOGO)
143. APPALACHIAN BREWING COMPANY (TREE LOGO)
144. ATWATER BREWERY (PIC OF MAN WITH MUG OF BEER) BREWED IN DETROIT
145. AZTEC BREWING COMPANY (PYRAMID LOGO) (VISTA CA MICRO)
146. BIG BEAVER BREWING CO. (PIC OF BEAVER HEAD) 'BOUT GOT 'ER LICKED LOVELAND, CO
147. BIG BOSS BREWING COMPANY (PIC OF STAR) * HAND CARFTED BREW * RALEIGH, NORTH CAROLINA
148. BIG WOODS BREWING CO. (PIC OF TREE) BROWN COUNTY, INDIANA
149. BIG WOODS BREWING CO. (LOGO) BUSTED KNUCKLE ALE BUSTED KNUCKLE (PIC OF FIST)
150. BLUE MOON (LOGO)
151. BUD LIGHT ONE BEER (WHITE ON BLUE) / RAIDERS (IN NFL SHIELD LOGO) ONE NATION (WHITE AND SILVER ON BLACK)
152. CASCO BAY BREWING CO. (BUOY LOGO)
153. CITY STEAM VERY HOPPY PALE ALE (PIC OF BLONDE HOLDING GLASS) (BLONDE ON BLONDE)
154. CITY STEAM XXXTRA IPA (PIC OF RED HEAD W/ GLASSES) (INNOCENCE)
155. COORS LIGHT. (MOUNTAIN LOGO) (ALL METAL NO PLASTIC INSERT)
156. CORONADO BREWING CO. (PIC OF MERMAID WITH MUGS OF BEER) CORONADO CA
157. DARK HORSE BREWING CO. MARSHALL MI (PIC OF HORSE & STAR)
158. DILLON DAM (LOGO) BREWERY COLORADO
159. DRY DOCK BREWING CO. (PIC OF MASTED SHIP)
160. DUST BOWL BREWING COMPANY EST. 2008 TURLOCK, CA (BARBED WIRE LOG)
161. EVO (IN LOGO) EVOLUTION CRAFT BREWING CO.
162. FEGLEY'S BREW WORKS (LOGO) ALLENTOWN, PA.
163. FIREHOUSE BREWING CO. (PIC OF HORSE PULLING OLD FIRE ENGINE) (RAPID CITY SD MICRO
164. THE FORT COLLINS BREWERY HANDCRAFTED IN FORT COLLINS, COLORADO (F C B ON BOTTLE CAP)
165. FOUNDERS BREWING CO. SINCE 1997 BREWED FOR US. GRAND RAPIDS, MICHIGAN
166. FULTON BREWING COMPANY (LOGO) WWW.FULTONBEER.COM
167. GRANITE MOUNTAIN BREWING PRESCOTT, ARIZONA
168. HORSEHEADS BREWING INC. (PIC OF 3 HORSE HEADS)
169. HYDE (PIC OF FDR) PARK BREWING COMPANY RESTAURANT & BREWERY
170. LAGERHEADS (PIC OF LAGERHEAD) BREWING CO. MEDINA OHIO
171. LAUGHING SOUL AMBER ALE (PIC OF BUG-EYED SKULL)
172. MAD RIVER BREWING COMPANY JAMAICA BRAND FINE ALES (IN LOGO) HUMBOLDT COUNTY, CA SINCE 1989
173. MANKATO BREWERY (MB 2010 IN LOGO) * MINNESOTA *
174. MIDDLE AGES BREWING COMPANY SYRACUSE, NEW YORK (M A LOGO)
175. MIDNIGHT SUN BREWING CO. ANCHORAGE, ALASKA (SUN GOD LOGO)
176. (M LOGO) MILWAUKEEBREWING.COM MILWAUKEE-BREWING.COM
177. MILWAUKEE BREWING COMPANY (MKE) MKEBREWING.COM #LUVMKECRAFT.
178. MISSION (PIC OF TWO SHIPS LOGO) BREWERY SAN DIEGO, CALIFORNIA
179. MOTHER'S BREWING COMPANY (ON LOGO) (SPRINGFIELD MO MIRO)
180. OMEGANG BREWERY (LOGO) COOPERSTOWN N. Y.
181. PISMO BREWING COMPANY EST 2010 PISMO BEACH CALIFORNIA (LOGO)
182. REAL ALE BREWING COMPANY (PIC OF TEXAS) BLANCO, TEXAS
183. REAL ALE BREWING 4 FIREMANS TEXAS CRUZER
184. RIVER CITY BREWING COMPANY (WAITER LOGO)
185. SEBAGO (PIC OF BOAT FRONT)
186. SKAGWAY BREWING CO. ESTABLISHED 1897 SKAGWAY, ALASKA (PIC OF MOUNTAINS & FIVE DIFFERENT SIZE BEER FERMENTING TANKS)
187. SLO BREW WWW.SLOWBREWINGCO.COM EST. 1988 RE-EST. 2010 (IN SMALL BANNER W/ HOPS)
188. SQUATTERS PUBS FINE ALES & LAGERS SINCE 1989 (PIC OF BUILDING) (UTAH MICRO)
189. STOUTS BREWING COMPANY (IN LOGO)
190. SUMMIT BREWING (PIC OF BUILDING)
191. THE BEACH CHALET BREWERY & RESTAURANT SAN FRANCISCO OCEAN BEACH GOLDEN GATE PARK (SITE BUILDING IMAGE)
192. THIRSTY DOG BREWING CO. (PIC OF DOG WITH MUG) EST. 1997
193. TROEGS INDEPENDENT CRAFT BREWERY PENNSYLVANIA HANDCRAFTED BY THE TROEGS BROTHERS (BLUE & RED ON TAN)
194. TURTLESTONE BREWING COMPANY (PIC OF TURTLE)
195. YARDS BREWING COMPANY PHILADELPHIA'S OWN EST. 1994
- B-73 CORRECTIONS
126. THE PIKE SEATTLE BREWING CO. (P IN STAR W/ HOPS) (DELETE USE #136)
- B-82
5. 8 0 5 (LOGO) (LOCAL BEER DISTRIBUTION ONLY USING AREA CODE FOR FIRESTONE/WALKER) (WHITE ON BLACK)
6. FIRESTONE (TRADEMARK F W ON BARRELS LOGO)

(SILVER ON BLACK)

- B-91
CAP LIFTER/SCREWDRIVER/KEY RING
(SEE B-28)
3"
JOHN STANLEY
- 1. HOSTER-COLUMBUS COL'S, O. DRINK GOLD TOP
"THAT'S THE BEER"
- B-92
CAP LIFTER/GAS KEY/CIGAR BOX OPENER
(SEE B-21)
3"
JOHN STANLEY
- 1. ME FOR RENNER & WEBER EAGLE EXPORT BEER
- B-93
CAP LIFTER/PLASTIC INSERT
(SEE B-73)
2 1/2"
JOHN FISHER/JOHN STANLEY
- 1. EVOLUTION CRAFT BREWING CO. (E V O IN LOGO)
- 2. TURTLE MOUNTAIN BREWING COMPANY (PIC OF MOUNTAIN) RIO RANCHO NEW MEXICO (ALL IN TURTLE LOGO)
- C-11
51. DRINK STEINERBRU BEER
- C-13
339. CARL EBNER BREWING CO.
- 340. (LOGO) WAGNER VALLEY BREWING CO. (LASER ENGRAVED)
- C-20
30. FAMOUS BEVERWYCK BEERS & ALES (BEVERWYCK SCRIPT LETTERS)
- 31. SCHNEIDER'S SPARKLING BEVERAGES WEST 0998
- C-45
52. DUST BOWL BREWING CO. (BARBED WIRE TORNADO LOGO) (BLACK, GOLD, & RED ON GRAY)
- C-49
154. ANCHOR (PIC OF ANCHOR) BREWING A SAN FRANCISCO BREWING TRADITION
- 155. ANGEL CITY BREWERY (INSIDE MOUNTAIN LOGO) (PIC OF ANGEL) (GOLD ON BLACK)
- 156. BATCH 19 PRE-PROHIBITION STYLE LAGER (FROM MILLER-COORS)
- 157. BROWN'S BREWING CO. (BROWN ON GREEN WOOD) (BROWN ON TAN WOOD)
- 158. DRAKE'S BREWING (SILVER ON CHROME)
- 159. DUST BOWL BREWING CO (BARBED WIRE TORNADO LOGO) (BLACK ON RED)
- 160. DUST BOWL BREWING CO. TURLOCK, CALIF. (BARBED WIRE LOGO) (BLACK ON CHROME)
- 161. EVO (IN LOGO) EVOLUTION CRAFT BREWING CO.
- 162. EXCELSIOR BREWING COMPANY (IN LOGO)
- 163. GORDON BIERSCHE BREWING COMPANY NEVER TRUST A SKINNY BREWER. (PIC OF MAN & MUG LOGO) (WHITE ON BLACK)
- 164. GREAT LAKES BREWING CO. GREATLAKESBREWING.COM (GRAY AND YELLOW ON BLACK)
- 165. GREEN FLASH BREWING CO. (PIC OF TRADEMARK 1/2 SUN RISING WITH POINTS)
- 166. * HANGAR 24 CRAFT BREWERY * / (ROW OF STARS) REDLANDS, CALIFORNIA (ROW OF STARS) WWW.HANGAR24BREWERY.COM (ROW OF STARS) (GOLD ON WHITE)
- 167. THOMAS HOOKER (H LOGO) (IN LOGO) CONNECTICUT'S BEER (BLACK ON STEEL)
- 168. PYRAMID BREWERIES (PYRAMID IMAGES LOGO) (RED, WHITE AND YELLOW ON BLUE VINYL)
- 169. (PYRAMID IMAGES LOGO ONLY) (ORANGE AND YELLOW BLACK VINYL)
- 90. SARANAC (WHITE ON RED VINYL)
- 170. THE PHOENIX ALE BREWERY (PIC OF MOUNTAIN SCENE) PHRESH BREWED ALE
- 171. 3FLOYDS.COM / (3 F'S CIRCLE LOGO) (BLACK ON

WHITE)

- 172. TRIPLE ROCK BREWING CO. BERKELEY CALIFORNIA / DEVOLVE (MONKEY FACE IMAGE) (WHITE ON BLACK STEEL)
- C-52
8. HONESTLY FRESH 19(S)72 STRAUB BREWERY FIERCELY INDEPENDENT. / PCC PRECISION COMPACTED COMPONENTS (LOGO)
- C-64
5. TRUMER PILS (LOGO OF BAR MAIDEN)
- C-73
8. PIZZA PORT BOTTLE BEER (IN LOGO)
- C-78
2. BEAR REPUBLIC
- C-81
5. BLUE POINT BREWING COMPANY (IN LOGO) LONG ISLAND
- 6. PROVO GIRL PILSNER (PIC OF SEXY GIRL) SQUATTERS BEERS FINE ALES & LAGERS SINCE 1989 (ON BOTTLE CAP)
- C-95
4. COLLEGE-STREET BREWHOUSE & PUB
- C-98
4. (LOGO 2 HEADS & 1 BODY HOLDING 2 MUGS FOR ROY PITZ BREWING CO) (CHAMBERSBURG PA MICRO)
- 5. YAZOO (LOGO) BREWING COMPANY NASHVILLE (WHITE ON RED)
- C-99
2. ELLIS ISLAND CASINO & BREWERY (IN ROUND LOGO)
- C-100
8. BUD LIGHT (C-LOGO)
- 9. BUDWEISER (SCRIPT LETTERS) CLYDESDALES (BLOCK LETTERS) (PIC OF HORSE) THE WORLD REKNOWN (IN BANNER)
- 10. THE LAB BREWING C (GLASS IMAGE LOGO)
- 11. VICTORY BREWING COMPANY W/ RED V
- C-102
CAP LIFTER
2 3/4"
JACK FORD/MIKE KREJCI
- 1. BUD (C LOGO) LIGHT
- C-103
CAP LIFTER
DOG TAGS (SEE C-72)
2"
ART SANTEN
- 1. BUDWEISER (IN CROWN LOGO)
- C-104
CAP LIFTER
CREDIT CARD SIZE OPENER
(SEE C-45, 68, 69, 71, 95, 97, 105, 106)
3 3/8"
MIKE KREJCI
- 1. COORS (UNDER MOUNTAIN LOGO)
- C-105
CAP LIFTER
CREDIT CARD SIZE OPENER
(SEE C-45, 68, 69, 71, 95, 97, 104, 106)
3 3/8"
MIKE KREJCI
- 1. MILLER LITE
- C-106
CAP LIFTER
CREDIT CARD SIZE OPENER
(SEE C-45, 68, 69, 71, 95, 97, 104, 105)
3 3/8"
MIKE KREJCI
- 1. SAMUEL ADAMS BOSTON BREWERY
- C-107
CAP LIFTER
2"
BILL MUMA
- 1. HOP VALLEY

- C-108
CAP LIFTER/TOP POPPER
3 1/2"
BEN HOFFMAN/MIKE KREJCI
1. MILLER LITE (IN LOGO) IT'S MILLER TIME. /
BOTTLE (PIC OF OPENER IN OPERATION) PUNCH TOP
CAN
- C-109
CAP LIFTER
(MAGNET ON BACK)
5 1/16"
JOHN STANLEY
1. (MOAB UT BREWERY LOGO)
- C-110
CAP LIFTER
3 5/16"
TODD BARNES/BRIAN COOLEY
1. MOTHER EARTH BREW CO. (IN M E LOGO) MOTHERE-
ARTHBREW.COM (WHITE ON BLUE)
- C-111
CAP LIFTER
2"
JOHN CARTWRIGHT
1. SUDWERK (DAVIS CA MICRO)
D-22
2. VOIGT'S NURISHIN MALT AND RHEINGOLD
E-4
401. HULL'S CREAM ALE / STAEHLY'S BOTTLING WORKS
402. KENT BREWING COMPANY WEST WARWICK, R. I. /
SAME
- E-5
158. KAIER'S BEER & PORTER CALL 52061 JOSEPH A BAL-
CHIUS ENDICOTT, N.Y.
- E-6
234. PITTSBURGH BREWING COMPANY / IRON CITY PILSE-
NER LAGER FOX HUNT ALE (NO PUNCTUATION)
- E-7
109. NIAGARA FALLS BREWING CO. SPRAY BEER.
- E-8
136. PORTLAND BREW. CO. EDEL BRAU. / SAME
- E-9
155. CARSON BREWING CO. DRINK-TA-HOE. / SAME
156. EL PASO BREWING ASSOCIATION. / SOUTHERN BUD
PREMIUM
157. HAFFENREFFER SPARKLING / HAFFENREFFER STOUT
E-14
871. CHEER UP WITH OERTEL BREWING CO. / OERTEL'S
'92 BEER LOUISVILLE, KY.
267. SOUTHERN SELECT BEER / SAME (2 VAR (A) NO
APOSTOPHES (B) WITH APOSTOPHES) (2013,261)
E-16
18. KRUEGER'S BEER "HIGH GRADE"
F-2
71. GLUEK BREWING CO. / INDIAN MAID GINGER ALE
F-3
20. "SUNSET BEER DISTRIBUTORS" UPPER DARBY, PA SU
9-8989 SU 9-5400
F-4
47. TIVOLI BEVERAGE COMPANY CORNER 8TH & NORMANDIE
FOR FREE DELIVERY EX. 2734 3450
F-6
141. DRINK WAGNER'S PRODUCTS FOR YOUR HEALTH'S
SAKE / WAGNER'S AUGUSTINER SPECIAL WAGNER'S
AUGUSTINER WAGNER'S FAMOUS MALT TONIC
142. WATERBURY MALT PRODUCTS CO. 34 BROOK STREET /
THIRST IS ETERNAL
F-8
4. GOENNER & CO. / JOHNSTOWN, PA. / NEW LIFE BEV-
ERAGE AND ICE / JOHNSTOWN, PA.
F-9
27. MILWAUKEE BREW / BAVARIAN BREW / MALTA VIGOR /
PRODUCTOS SUPERIORES MADE IN U. S. A.
F-15
19. UTICA CLUB THE NATURAL BEER
F-16
5. LAKESHORE PRODUCTS CO. PLANT NO. 2 LA CROSSE
WIS. / ORIGINAL MALT SYRUP
F-24
7. "PICK" SCHNEIDER'S GRAND PRIZE BEVERAGES
AWARDED 2 PRIZES IN 2 YEARS LIEGE 1926 PARIS
1927 GEO. SCHNEIDER & CO. 177-183 STOCKHOLM
STREET FOXCROFT 8440-8441 B'KLYN., N. Y.
G-5
56. COOK'S BEER EVANSVILLE, IND.
57. MOHAWK VALLEY BREWING CO. SCHENECTADY, N. Y.
G-9
108. DOWN'S BEER-ALE (BLACK ON RED)
G-25
11. HOFFMAN BEVERAGE CO. PHONE 1385 MAIN
G-35
19. LONG TRAIL BREWING (WHITE ON GREEN)
G-36
9. MAGIC HAT 9
G-48
80. BUDWEISER SELECT (CROWN LOGO) (LEFT-HANDED)
(SILVER ON BLACK)
81. CAPE MAY BREWING COMPANY (WHITE ON GREEN)
82. (PIC OF BASEBALL) COOPERSTOWN BREWING CO.
(WHITE ON RED)
83. THE GRAND CANYON BREWING COMPANY GRANDCANYON-
BREWERY.COM (WHITE ON BLACK) (WHITE ON RED)
84. GREAT LAKES BREWING CO. (PIC OF GLOBE ON BOT-
TLE CAP) (GRAY ON BLACK) (WHITE ON BLUE)
(WHITE ON RED)
85. HARPOON (RED ON SILVER)
86. HOPTECH.COM A HOBBY YOU CAN DRINK 925-875-0246
(WHITE ON BLUE)
87. HORSEHEADS BREWING (WHITE ON RED)
88. MAGIC * HAT (WHITE ON BLACK) (WHITE ON GREEN)
(WHITE ON PURPLE)
89. ^ MCMENAMINS ^
90. NATURAL LIGHT (BLUE ON SILVER)
91. NEWPORT STORM (RED ON YELLOW)
69. OAK CREEK BREWING CO. WWW.OAKCREEKBREW.COM
(WHITE ON BLUE)
92. PRESCOTT BREWING COMPANY PRESCOTT, ARIZONA
(WHITE ON BLACK) (WHITE ON GREEN)
93. SHINER BEERS (BLACK ON YELLOW)
94. SCHOCK@TOP (WHITE ON GOLD)
95. TRUMER PILS (BLACK ON SILVER)
96. (LOGO) WAGNER VALLEY BREWING CO. (WHITE ON
BLUE)
G-49
2. DESCHUTES BREWERY ESTD. 1988 BEND OREGON
G-97
3. KONA BREWING CO. HAND CRAFTED ALES (PIC OF
LIZARD) KONA HAWAII (ON NECK LABEL) KONA BREW-
ING CO. BIG WAVE GOLDEN ALE (WAVE SCENE) (ON
BODY LABEL) WWW.KONABREWINGCO.COM
4. KONA BREWING CO. HAND CRAFTED ALES (PIC OF
LIZARD) KONA HAWAII (ON NECK LABEL) KONA BREW-
ING CO. LIMITED RELEASE PIPELINE PORTER MADE
WITH 100% HAWAIIAN KONA COFFEE (MAN W/ SURF-
BOARD SHORE SCENE) (ON BODY LABEL)
WWW.KONABREWINGCO.COM
5. KONA BREWING CO. HAND CRAFTED ALES (PIC OF
LIZARD) KONA HAWAII (ON NECK LABEL) KONA BREW-
ING CO. LIMITED RELEASE WAILUA WHEAT BREWED
WITH TROPICAL PASSION FRUIT (GIRL AT WATERFALL
SCENE) (ON BODY LABEL) WWW.KONABREWINGCO.COM
G-98
2. SINCE 1829 (ON NECK LABEL) SINCE 1829
YUENGLING ORIGINAL BLACK & TAN DARK BREWED
PORTER & PREMIUM BEER AMERICA'S OLDEST BREWERY
(ON BODY LABEL) / SAME

- | | |
|--|--|
| <p>G-99
17. BRIDGEPORT BREWING (GRAY ON RED)
18. SHINER BEERS (BLACK ON GOLD)
G-101
9. (LOGO) UPLAND BREWING CO. / DRINK LOCAL
(BLOOMINGTON IN MICRO) (WHITE ON GREEN)
G-106
2. HOFBRAU ORIGINAL HB LOGO (BUILDING SCENE) (ON
BODY LABEL) (HB LOGO HOFBRAU MUNCHEN ON NECK
LABEL) (MAGNET ON BACK)
3. RED TAIL ALE BREWED & BOTTLED BY MENDOCINO
BREWING CO. HOPLAND, CA (ON BODY LABEL) (EAGLE
LOGO ON NECK LABEL)
4. SINCE 1828 YUENGLING ORIGINAL BLACK & TAN
AMERICA'S OLDEST BREWERY (ON BODY LABEL)
YUENGLING (ON NECK LABEL)
G-116
2. BEMIDJI BREWING
G-125
2. TRUMER PILS
G-144
4. MAD CROW (PIC OF RED CROW) BREWERY & GRILL 941
-954-2337
5. MILLER LITE (IN LOGO) DETROIT TIGERS BDA/MLBP
2011
G-152
2. GRITTY'S (IN LOGO) MAINE'S ORIGINAL BREWPUB
G-154
10. BUD LIGHT (C-LOGO) (PIC OF FOOTBALL ON GRASS)
G-158
CAP LIFTER
3 1/4"
TODD BARNES/JOHN CARTWRIGHT/BRIAN COOLEY
1. ALESMITH (PIC OF BEER ON ANVIL) BREWING COM-
PANY
G-159
CAP LIFTER
3 1/4"
JOHN CARTWRIGHT/MIKE KREJCI/JOHN STANLEY
1. ANGEL CITY BREWERY (PIC OF BUILDING & HALO)
ANGELCITYBREWERY.COM / SAME
G-160
CAP LIFTER
2 3/8"
MIKE KREJCI
1. BUDWEISER / (PIC OF BOTTLE) BUDDY UP!
G-161
CAP LIFTER
2 1/8"
JOHN CARTWRIGHT
1. CISCO BREWERS NANTUCKET, MA (508)325-5929 /
(LOGO)
G-162
CAP LIFTER
2 5/8"
MIKE KREJCI
1. COORS / LOGO
G-163
CAP LIFTER
MARKED "(LOGO) PD CHINA"
2 11/16"
TODD BARNES/JOHN CARTWRIGHT/BRIAN COOLEY
1. GREEN FLASH BREWING CO. (PIC OF SUN) SAN
DIEGO, CALIFORNIA
G-164
CAP LIFTER
THICK STEEL
2 1/2"
JOHN CARTWRIGHT
1. HANGAR 24 (PIC OF AIRPLANE) CRAFT BREWERY
REDLANDS, CA / H*24 HANGAR 24 CRAFT BREWERY
HANGAR24BREWERY.COM</p> | <p>G-165
CAP LIFTER
2 3/8"
MIKE KREJCI
1. GEORGE KILLIANS IRSH RED (PIC OF HORSEHEAD)
EST'D. 1864
G-166
CAP LIFTER
3 1/4"
JOHN STANLEY
1. MAGIC HAT (#9)
G-167
CAP LIFTER
2 5/8"
JOHN CARTWRIGHT
1. NINKASI BREWERY EUGENE, OREGON (N LOGO) BEER
IS LOVE / NINKASI BREWERY EUGENE, OREGON (N
LOGO)
G-168
CAP LIFTER
(SEE G-83)
3 1/2"
MIKE KREJCI
1. BREWERY OMEGANG / SAME
G-169
CAP LIFTER
2 5/16"
MIKE KREJCI/ART SANTEN
1. OTTER CREEK BREWING (O B C LOGO) MIDDLEBURY,
VT. / SAME
G-170
CAP LIFTER/BOTTLE SHAPED
2 5/8"
MIKE KREJCI
1. SAMUEL ADAMS BOSTON LAGER
G-171
CAP LIFTER
2 5/16"
BEN HOFFMAN/MIKE KREJCI
1. SPRECHER BREWING CO., INC. (LOGO) ESTABLISHED
IN MILWAUKEE-1985 / ESTABLISHED 1985 PROUDLY
BREWING FOR 25 YEARS!
G-172
CAP LIFTER
2 5/8"
PAT STAMBAUGH
1. SUMMIT (LOGO BREWING CO. EST. 1986 ST. PAUL,
MINN. / SAME
G-173
CAP LIFTER
3"
TODD BARNES/BRIAN COOLEY
1. TWO BROTHERS BREWING CO. (PIC OF GLASS) /
SAME
G-174
CAP LIFTER
2 3/8"
TODD BARNES
1. UINTA BREWING CO. (LOGO) EARTH, WIND AND
BEER / SAME
G-175
CAP LIFTER
3 1/4"
JOHN CARTWRIGHT
1. WIDMER (W LOGO) BROTHERS PORTLAND, OR / PORT-
LAND TIMBERS (T LOGO) PORTLAND, OR
H-2
230. DICK & BROS. QUINCY, ILL. NEARO (RIGHT-HANDED)
I-6
100. CHURCH KEY CAN CO. (LOGO) IT'S WORTH THE EF-
FORT
I-15
76. CHURCH KEY CAN CO. (LOGO)</p> |
|--|--|

- | | |
|--|---|
| <p>I-28
2. COORS AMERICA'S FINE LIGHT BEER / SAME
J-14
CAP LIFTER/PLASTIC INSERT
2 1/2"
JOHN CARTWRIGHT
1. SKYSCRAPER BREWING COMPANY (PIC OF SKY-
SCRAPER) (LA CA MICRO)
K-5 CORRECTIONS
4. MILLER HIGH LIFE (METAL TAG ON BROWN SPOTTED
ON WHITE BASE)
K-16
HEAVY PORCELAIN BAR MOUNT
MARKED ON BRASS TAG "MANUFACTURED BY
THE AIR SCALE COMPANY TOLEDO, OHIO, U.S.A."
7 3/4"
JOHN STANLEY
1. PABST (EMBOSSSED ON HANDLE) PABST
(SILKSCREENED ON BASE)
L-14
49. WATER STREET BREWERY MILWAUKEE * WI DELAFIELD
* WI (PIC OF BREWERY BUILDING) WATER STREET
BREWERY (ON NECK)
L-22
CAP LIFTER/PLASTIC BOTTLE
(SEE Z-2)
MARKED "MADE IN CHINA"
7 7/8"
VERNE VOLLRATH
1. GOOD OLD POTOSI BEER PBC (IN LOGO) BREWED
WITH WISCONSIN SPRING WATER CONTENTS 12 FLUID
OUNCES-BREWED AND BOTTLED BY @POTOSI BREWING
COMPANY, POTOSI, WISCONSIN (ON BODY LABEL)
POTOSI PBC (IN LOGO) (ON NECK LABEL)
M-2
23. HENRY HESS BREW'G CO. PHILADELPHIA PREMIER
BEER
24. PORTLAND BREWING CO. EDELBRAU (EDELBRAU ON
BOTTLE) (ON CONVEX SIDE)
M-3
47. EICHLER'S BEER / ESTABLISHED 1862 / NEW YORK,
N. Y. (RED)
M-3 CORRECTIONS
43. QUEEN CITY BREWING CO. / CUMBERLAND, MD. /
THE ORIGINAL OLD GERMAN BEER (RED/OTT) (ADD
CO.) (2013,261)
M-26
8. MAHAN SUPPLY CO. WHOLESALE BEER & LIQUORS
WICHITA, KANSAS. (SEE L-2-16 BUDWEISER AND L-2
-25 ANHEUSER-BUSCH)
M-30
199. BALLANTINE (LOGO) SCHLITZ (LOGO) CHOPTANK DIS-
TRIBUTING CO. INC. ED & CHARLIE POWELL EAST
NEW MARKET, MD. 943-4573
200. DISTRIBUTOR OF BALLANTINE-DUBOIS-GENESEE BEER-
ALE SHOPPING CENTER BEER DISTRIBUTOR GREENS-
BURG, PA.-PHONE TE 7-4570
201. STAG BEER ON DRAFT-MIXED DRINKS JOHNSON'S TOWN
CLUB PACKAGE GOODS-GROCERIES PH. 656-9000 CAR-
PENTER, ILLINOIS
M-60
13. STAG BEER (IN LOGO) DISTRIBUTOR J. H. RUTLEDGE
POTOSI, MO.
M-89
13. HANDY BOTTLE OPENER FOR BUDWEISER SOUTHERN
DISTRIBUTING COMPANY, INC. HERRIN, ILLINOIS
14. COMPLIMENTS OF EMITT COPELAND FALSTAFF 2650
ARSENAL ST. ST. LOUIS, MO.
M-179
5. KENNEBUNKPORT BREWING CO. (LOGO)
6. SHIPYARD BREWING CO. APPLEHEAD (PIC OF MAN ON
HORSE W/APPLEHEAD HOLDING UP PINT GLASS)
7. SHIPYARD BREWING CO. IPA FUGGLES INDIA PALE</p> | <p>ALE (PIC OF HOPS W/ HOUSE ON LAKE WITH TREES)
M-183
CAP LIFTER
2"
JOHN STANLEY
1. EPIC BREWING (IN LOGO) EPIC BREWING CO. SALT
LAKE CITY, UT (WHITE ON GRAY)
M-184
CAP LIFTER/WOODEN HANDLE
5 1/2"
JOHN CARTWRIGHT
1. FIRESTONE WALKER BREWING COMPANY
M-185
CAP LIFTER/LUGGAGE TAG
TWIST-OFF CAP LIFTER IN HANDLE (SEE M-90, 114)
3 3/8"
ART SANTEN
1. MILLER LITE (IN LOGO) / SAME
M-186
CAP LIFTER/WOODEN COASTER
3 1/2"
JOHN BITTERMAN
1. CANE AND EBEL HOPPED UP RED RYE ALE ALE
BREWED WITH RYE AND PALM SUGAR
2. DOG DAYS DORTMUNDER STYLE LAGER BEER
3. DOMAINE DUPAGE FRENCH STYLE COUNTRY ALE
4. EBEL'S WEISS BEER
5. LONG HAUL SESSION ALE
6. MONARCH OUR ANNIVERSARY BREW WHITE BEER
7. NORTH-WIND IMPERIAL STOUT
8. PRAIRIE PATH GOLDEN ALE
9. RESISTANCE INDIA PALE ALE
10. THE BITTER END PALE ALE
11. TWO BROTHERS BREWING CO WARRENVILLE IL
M-187
CAP LIFTER/WOODEN HANDLE
4 1/4"
JOHN CARTWRIGHT
1. WIDMER BROTHERS BREWING
N-3
12. GRAIN BELT DIST. CO. BUD ANDREWS
N-9
56. STONEY'S "AMERICA'S BEST BEER" SMITHTON, PA.
N-27
31. TO A SHARP FRIEND FROM THE BREWERS OF HOLIDAY
AND GARTENBRAU BEER THE FRIENDLY FOLKS IN PO-
TOSI VALLEY
32. SCHLITZ (IN BOX LOGO) COMPLIMENTS A & G DIS-
TRIBUTING CO. PALMER & WALT DECORAH, IOWA
N-35
23. CITY CLUB SALES CO. NORFOLK NEBR. / COMPLI-
MENTS OF F. L.ABEL
N-36
17. BEMIDJI DISTRIBUTING CO. "FRIENDLY GRAIN BELT
BEER" PHONE 37 BEMIDJI, MINN.
N-40
51. COORS LIGHT (MOUNTAIN LOGO)
52. FCB / "AMERICAN HERITAGE COMPANY THE FORT
COLLINS BREWERY HAND-CRAFTED IN FT. COLLINS,
COLORADO
N-41
11. HAMM'S BEER SINCE (LOGO) 1865 (GOLD ON BLACK)
N-50
5. POTOSI BREWING CO. POTOSI, WIS.
N-56
44. MILLER HIGH LIFE SAFETY AWARD
N-70
3. BELLAIRE BREWING CO. BELLAIRE, OHIO.
N-85
4. THE FAMOUS UTICA BEER
N-106
3. (PIC OF ESSLINGER MAN) ESSLINGER'S BEER-ALE-
HALF & HALF BOTTLES, CANS ON DRAUGHT / H.</p> |
|--|---|

GITLIN SALES CO. N. E. REP. ESSLINGER'S INC.
 339 NEWBURY ST. BOSTON, MASS. CO 6-7320
 N-139

- 6. SIERRA NEVADA BREWING CO. / NON LOAD BEARING (WHITE ON METALLIC MINT GREEN)
 N-142
- 3. HOFBRAUHAUS LAS VEGAS (HB IN CROWN LOGO) (LIGHT BLUE ON BLUE)
 N-151
- 2. COORS LIGHT (16 TIMES) / GAPPROMOTIONS 888-88GOGAP
 N-157

- 9. HORSEHEADS BREWING 250 OLD ITHACA RD. (WHITE ON RED)
 N-160

- 5. DESCHUTES BREWERY CHAINBREAKER WHITE IPA (WHITE ON BLUE) (STANDARD 4 CHAIN LINKS)
- 6. DESCHUTES BREWERY CHAINBREAKER WHITE IPA (WHITE ON BLUE) (VARIATION 10 CHAIN LINKS)
- 7. FOUNDERS BREWING (WHITE ON BLUE) (WHITE ON GREEN) (WHITE ON ORANGE) (WHITE ON RED)
- 8. MCMENAMINS (WHITE ON BLUE) (WHITE ON GREEN)
- 9. SQUATTERS BEER (WHITE ON GOLD)
 N-166

- 3. ELLIS ISLAND CASINO & BREWERY LAS VEGAS, NV
 N-174
- 2. PYRAMID HEFEWEIZEN UNFILTERED WHEAT ALE EST. 1984 (ON PIC OF PYRAMIDS LABEL) / SAME (CREAM ON BLUE)
 N-179

- 3. GRAND CANYON BREWING COMPANY
 WWW.GRANDCANYONBREWERY.COM (REPEATS 5 TIMES)
 (BLACK ON RED) (BLACK ON WHITE)
 N-187

DOUBLE BLADE KNIFE
 CAP LIFTER-SCREWDRIVER BLADE/PEN BLADE
 1 15/16"

- 1. BREWHOUSE *
 TODD BARNES/DARVIN STILWELL
 N-188
 TWO CAP LIFTERS/BOTTLE STOPPER
 2 3/8" CLOSED
 BRIAN COOLEY

- 1. THE BRUERY
 N-189
 CAP LIFTER/FLASHLIGHT
 2 5/8"
 JOHN STANLEY

- 1. BUD KING OF BEERS 8 DALE JR
 N-190
 CAP LIFTER/FLASHLIGHT/EIGHT BLADE KNIFE/
 CAN-BOTTLE OPENER SMALL SCREWDRIVER BLADE/
 SCREWDRIVER BLADE W/ 6MM & 7MM WRENCHES/
 FILE-MEDIUM SCREWDRIVER BLADE/
 PEN BLADE/SAW BLADE/
 SMALL PHILLIPS SCREWDRIVER BLADE/
 SCISSORS BLADE/
 FISH HOOK REMOVER-FISH SCALER BLADE/
 FLASHLIGHT & RED SIGNAL FLASHER
 6"

- 1. BUDWEISER (IN CROWN LOGO)
 ART SANTEN
 N-191
 CAP LIFTER/FOUNTAIN PEN
 5 1/8"
 MIKE KREJCI/ART SANTEN

- 1. BUDWEISER (CROWN BOWTIE LOGO)
 N-192
 CAP LIFTER/DIVOT TOOL/
 MAGNET FOR HOLDING BOTTLE CAP/GOLF BALL MARKER
 MADE IN CHINA
 DESIGNED BY RICHARD L BEARD
 DESIGN PATENT NO. 567,319 (04/22/2008)

3 3/4"
 ART SANTEN

- 1. MICHELOB ULTRA
 N-193
 CAP LIFTER/PIZZA CUTTER
 5 1/2"
 BEN HOFFMAN/MIKE KREJCI
- 1. MILLER LITE (IN LOGO) MAN UP. CHOOSE THE TASTE. / BOTTLE OPENER
 N-194
 DOUBLE CAP LIFTER/DOUBLE CARABINER
 3 1/4"
 JOHN CARTWRIGHT
- 1. SIERRA NEVADA BREWING CO. SIERRA NEVADA (IN LOGO) NOT FOR CLIMBING (PIC OF BOTTLE CAP) (NI LOGO) (PIC OF BOTTLE CAP) PATENT PENDING CHINA

N-195
 CAP LIFTER/STICK
 (SEE N-76)
 4 1/4"

- MIKE KREJCI
- 1. MILLER GENUINE DRAFT (MILLER G D BOTTLE)
 O-1
- 11. WALTER BREWING CO. EAU CLAIRE, WISC.
 O-2
- 30. HAMM'S BEER (PIC OF HAMM'S BEAR) FROM THE LAND OF SKY BLUE WATERS
- 31. HYDE PARK TRUE LAGER BEER (IN SHIELD LOGO)
- 32. THE LARGAY BREWING CO., INC. WATERBURY, CONN. RED FOX (PIC OF FOX SERVING BOTTLE OF BEER WITH TWO GLASSES) ALE
 O-4
- 55. BERGHOFF PRODUCTS MFG. CO. INC.
 O-5

- 95. BIG BOSS BREWING CO. (RALEIGH NC MICRO) (PAINTED LETTERS)
- 96. BLUE POINT BREWING COMPANY LONG ISLAND (LOGO) (PAINTED LETTERS)
- 97. BROOKLYN LAGER (LOGO) (PAINTED LETTERS)
- 98. CISCO BREWERS NANTUCKET (PAINTED LETTERS)
- 99. COORS (PAINTED LETTERS)
- 100. DOGFISH HEAD CRAFT BREWED ALE (FISH LOGO) (PAINTED LETTERS)
- 101. EMPIRE BREWING COMPANY SYRACUSE, NEW YORK (LOGO) (PAINTED LETTERS)
- 102. EMPIRE BREWING COMPANY HAND CRAFTED ALES AND LAGERS (LOGO) (PAINTED LETTERS)
- 103. FALLS CITY BEER (PAINTED LETTERS)
- 104. FOUNDERS BREWING CO. (PAINTED LETTERS)
- 105. GENESEE BEER (PAINTED LETTERS)
- 106. GREAT LAKES BREWING CO. (PAINTED LETTERS)
- 107. HARPOON BREWERY (SPEAR LOGO) (PAINTED LETTERS)
- 108. HIGHLANDER BEER (PAINTED LETTERS)
- 109. HONEY BROWN J W DUNDEE'S ORIGINAL (PAINTED LETTERS)
- 110. LEFT HAND BREWING CO. (HAND LOGO) (PAINTED LETTERS)
- 63. MILLER HIGH LIFE (LARGE RED PAINTED LETTERS) (SMALL RED PAINTED LETTERS)
- 111. (PIC OF BICYCLE) NEW BELGIUM BREWING COMPANY (PAINTED LETTERS)
- 112. ODELL BREWING CO. (IN LOGO) (PAINTED LETTERS)
- 113. PETE'S WICKED (PAINTED LETTERS)
- 114. SHINER BEERS (PAINTED LETTERS)
- 115. SIERRA NEVADA BREWING CO. EST. 1980 (LOGO) (PAINTED LETTERS)
- 116. SWEETWATER BREWING COMPANY (FISH LOGO) (PAINTED LETTERS)
- 117. SWEETWATER BREWING COMPANY (FISH LOGO) DON'T FLOAT THE MAINSTREAM! (ON BOTTLE CAP)
- 118. TERRAPIN BEER CO. ATHENS, GA. (PAINTED LET-

- TERS)
119. THIRSTY DOG BREWING CO. EST. 1997 (DOG HOLDING A MUG LOGO) (PAINTED LETTERS)
120. TROEGENATOR (LOGO) (DECAL)
O-6
12. BOH BOHEMIAN LAGER BEER DE-LIGHT-FUL (PIC OF HAT WITH A FEATHER)
13. ESSLINGER'S BEER ALE (PIC OF WAITER) ..MELLOW.. ..LIGHT.. ..."JUST RIGHT"...
14. FITZGERALD BEER AND ALE BRING OUT THE BEER WITH A SMILE (F IN FACE LOGO)
15. GRAND PRIZE BEER (GP LOGO)
16. GUNTHER'S BEER A FEATHER IN OUR CAP (QUALITY IN A PIC OF FEATHER) (ALL IN PIC OF BOTTLE CAP)
17. KRUEGER'S BEER AND ALES SINCE 1858 (PIC OF K MAN)
18. NATIONAL BOHEMIAN (PIC OF MR BOH WITH SERVING TRAY)
O-8
29. KEY TO BURKHARDT'S BEER
O-30
CHROMED WALL MOUNT CAP LIFTER
3"
MIKE KREJCI
1. MILLER GENUINE DRAFT STURGIS NORTH PROMOTIONS INC.
P-6
15. AVON BOTTLING CO. PHONE BI. 3-0200 P. O. N. BEER DISTRIBUTOR (BLACK ON GREEN)
P-7
68. BURKHARDT'S "THE ORIGINAL" COPYRIGHT 1912 BEER ALE AND PORTER RECEIVED GRAND PRIZE AND GOLD MEDAL AT THE INTERNATIONAL PURE FOOD EXHIBITION AT PARIS 1914 BOTTLED BY THE BURKHARDT BREWING CO. ROXBURY CROSSING, MASS. A CASE OF GOOD TASTE COPYRIGHT 1912
69. "HOLLAND SYSTEM" WINES & LIQUORS, MAIN OFFICE 47 BOYLSTON ST. WAREHOUSE HAYMARKET SQ. BOSTON (P-7-33)
70. COMPLIMENTS OF BARTHE & BECKER CELEBRATED MOUNTAIN BROOK WHISKEY POPULAR RAINIER BEER. 315 SECOND ST. MARYSVILLE, CAL.
P-14
33. PABST BEERS KOOL-RITE SALES CO. / REPUBLIC 0810
P-15
28. MANUFACTURERS OF QUALITY BEVERAGES. DIST. OF WALTER'S & BLATZ BEER / STANLEY BOTTLING WORKS, SYLVESTER M. HULS, PROP. PHONE - 17 STANLEY, WIS.
P-19
185. SOLE AGENTS FOR ANHEUSER-BUSCH BREWING ASSN. COMPLIMENTS OF L. ROSENFELD 519-521 MAIN STREET, COUNCIL BLUFFS, IOWA.
186. HENCO BREWERY SPOKANE, WASH. GENUINE LAGER
187. PEARL XXX BEER A SPECIALTY. HOTEL SALCE BAR AUSTIN, TEXAS. WM. H. SALCE, PROP.
188. COMPLIMENTS OF POTTS & SMITH, 200 SOUTH MAIN ST. SCHLITZ BEER ON DRAUGHT.
189. JOHN MICHELS, SOLE AGENT, SCHLITZ BREW'G CO., THE BEER THAT MADE MILWAUKEE FAMOUS, MITCHELL, - S. DAK.
190. DRINK SO. OMAHA BREWING CO'S GOLD TOP NEBRASKA'S FAVORITE BEER.
P-36
10. DIAMOND SPRING BEVERAGE CO. HAMM'S BEER
11. OELWEIN BOTTLING WORKS DIST. OF HAMM'S BEER PHONE 411
P-51
87. DREWRY & SONS, ST. PAUL, MINN. / MALT & CARBONATED BEVERAGES / BAR GLASSWARE AND SUPPLIES
P-51 CORRECTIONS
66. COLUMBIA BREWERY A. W. ELLIS, PROP. SUMPTER, - OREGON / NUGGET BRAND BOTTLE BEER (ADD A. W. ELLIS, PROP. AND DASHES) (2013,587)
P-54
58. HIGH GRADE LIQUORS, HIGH GRADE CIGARS -ERNEY'S - ERNEST J. GEELHAAR, PROP., FRED BAUERN-SCHMIDT'S BEER DRAWN DIRECT FROM KEG, 1132 HILLEN ST., BALTIMORE, - MD.
P-85
20. THE HUBERT FISCHER BREWERY BOTTLED ALES & LAGER HARTFORD, CONN.
P-87
2. THE SPRINGFIELD BREWING CO.
P-147
2. MCMENAMINS EDGEFIELD WINERY EST. 1990 (GOLD ON BLUE)
P-163
3. COMPLIMENTS OF BELLAVANCE'S WHOLESALE & RETAIL BOTTLER PIEL BROS. GERMAN BEERS & KING'S BOHEMIAN LAGER A SPECIALTY 2 AND 4 CANAL ST. NASHUA, N. H. TELEPHONE 284
P-205
CORKSCREW
IN METAL SLEEVE
(SEE P-18 & 19)
JOHN STANLEY
1. GEORGE KNERR, THE MILWAUKEE BLATZ BEER 110 EAST 12TH STREET, KANSAS CITY, MO.
P-206
WAITER'S FRIEND/CORKSCREW/CAP LIFTER/
WIRE CUTTER KNIFE
MARKED "PULLTAP'S PATENT"
TODD BARNES
1. BOULEVARD (GOLD ON BLACK) (GOLD ON GREEN) (GOLD ON BURGUNDY)
P-207
ELEVEN BLADE KNIFE/CORKSCREW/
LIFTER-CAN OPENER BLADE/MASTER BLADE/
SCISSORS BLADE/SAW BLADE/FISHER SCALER BLADE/
PHILLIPS SCREWDRIVER BLADE/
NAIL CLEANING BLADE/PUNCH BLADE/PUNCH BLADE
METAL HANDLES
MASTER BLADE MARKED "ESP K&R ASI #63770 /
STAINLESS ROSTFREI"
MIKE KREJCI
1. SHIPYARD BREWING CO.
Q-10
57. BUD LIGHT BEER (IN LOGO) THE BEST...TASTE IT!
58. BUD LIGHT BRING OUT YOUR BEST.
59. HEY GIMME AN I-C-LIGHT NATURALLY BREWED I-C LIGHT
Q-11
40. MIDDLE AGES BREWING COMPANY SYRACUSE, NEW YORK (M A LOGO) (GOLD ON BLACK) (SILVER ON BLUE) (SILVER ON GREEN) (SILVER ON RED)
41. SCHELL'S BREWING CO. (IN SLANTED RECTANGLE) (WHITE ON BLUE)
42. STRAUB BREWERY (BURGUNDY ON SILVER)
Q-18
270. BIG DOG'S BREWING CO. (PIC OF DOG HEAD LOGO) (WHITE ON BURGUNDY)
271. ISLAND BREWING COMPANY (805) 745-8272 (BLACK ON YELLOW)
272. PISMO BREWING COMPANY EST. 2010 WWW.PISMOBREW.COM (LOGO) (BLACK ON CORAL)
Q-27
29. PELICAN PUB & BREWERY (PELICAN IN LOGO) (BLUE ON WHITE & YELLOW) (WHITE ON RED & BLUE)
Q-31
144. COORS ARTIC ICE (SILVER ON BLACK)
145. LAKE PLACID CRAFT BREWING U B U ALE (WHITE ON BLACK)
146. SARANAC (PIC OF PUMPKIN FACE) PUMPKIN ALE

- (BLACK ON ORANGE)
147. TWISTED PINE (PIC OF PINE) BREWING COMPANY
BOULDER, COLORADO (303) 786-9270
Q-32
131. BLUE MOON (PIC OF MOON) SLIGHTLY UNUSUAL ALES
132. TAP HUNTER (PIC OF TAPS AND PINT GLASS) (BLACK ON YELLOW) (COMPANY PROVIDING AN APP FOR FINDING BEER/BREWERY/STORES)
133. THIRD STREET BREWHOUSE ST. CLOUD TIMES (BLACK ON WHITE)
Q-36
109. CROSS ROADS (BLUE ON WHITE) (A-B PRODUCT)
110. HILAND (PIC OF TREE) ORCHARD & BREWERY STURBRIDGE, MA (877) HYLANDS WWW.HYLANDBREW.COM
111. PABST BLUE RIBBON BEER (IN RIBBON LOGO)
Q-64 CORRECTIONS
3. VALLEY BREW. STOCKTON, CA (209) 464-2739
(GREEN ON WHITE) (DELETE RELISTED AS Q-84)
Q-66 (CORRECTIONS)
(DELETE USE Q-17-3)
TWIST OFF CAP LIFTER/TAB LIFTER
MARKED "PAT. PEND."
LOTTERY TWISTER-TAB LIFTER"
2 9/16"
JACK WESTALL
1. STROH'S (DELETE USE Q-17-3)
Q-67
8. BEACH (PIC OF SUN) BUM BLONDE ALE (RED ON YELLOW)
Q-84
18. VALLEY BREW. STOCKTON, CA (209) 464-2739
(GREEN ON WHITE)
Q-104
2. BLUE MOON (IN LOGO)
Q-120
2. WWW.PIZZAPORT.COM (LIGHT BLUE ON YELLOW)
Q-124
CAP LIFTER
4 3/4"
MIKE KREJCI/ART SANTEN
1. BUD (C LOGO) LIGHT
Q-125
CAP LIFTER
5 1/8"
MIKE KREJCI
1. MIKE'S (IN LEMON LOGO) KEEP THE PARTY SCREAMING!
Q-126
CAP LIFTER/BASKETBALL OR GOLF BALL SHAPE TOP
MADE IN CHINA
2 1/8"
MIKE KREJCI
1. MILLER LITE (IN LOGO) (ON BASKETBALL TOP)
2. MILLER LITE (IN LOGO) (ON GOLF BALL TOP)
Q-127
CAP LIFTER/FOOTBALL SHAPE TOP
MADE IN CHINA
2 3/8"
MIKE KREJCI
1. MILLER LITE (IN LOGO)
Q-128
PLASTIC TOP POPPER FOR CAN TABS
(SEE Q-5 & Q-6)
MARKED "PAT.PEND."
2 1/8"
GREG & KAREN LOY
1. STROH'S BEER (WHITE ON RED)
R-19
9. LAGUNITAS BREWING CO. TAPROOM AND BEER SANCTUARY 707.778.8776 WWW.LAGUNITAS.COM BEER SPEAKS. PEOPLE MUMBLE. (BLACK ON WHITE) (WHITE ON BLACK) (WHITE ON BLUE) (WHITE ON GREEN) (WHITE ON RED)
- R-24
9. MAMMOTH BREWING COMPANY (IN BANNER) (WHITE ON PURPLE)
10. SNOW CAP WINTER WARMER 25TH ANNIVERSARY PYRAMID BREWERIES (PYRAMID LOGO) (WHITE ON BLACK)
R-37
4. LEFT HAND BREWING CO. (PIC OF LEFT HAND)
R-42
4. SHINER BOHEMIAN BLACK LAGER EST. 1909 SPOETZL BREWERY SHINER TX (LOGO)
R-57
3. HOFBRAUHAUS LAS VEGAS (HB IN CROWN LOGO) (CAN OPENER/CAN PIERCER TOP)
4. SILVERTON BREWERY (MOUNTAIN LOGO) SILVERTON, COLORADO
R-67
2. BIG SKY BREWING CO. TROUT SLAYER WHEAT ALE (WHITE ON BLACK) (WHITE ON BLUE) (WHITE ON COPPER) (WHITE ON GREEN) (WHITE ON PURPLE) (WHITE ON RED)
- R-68 CORRECTIONS
4. BUFFALO BILLS BREWERY ALIMONY ALE (MAN SCREAMING LOGO) (DELETE RELISTED AS R-71)
5. SANTA CRUZ MOUNTAIN BREWING (PIC OF WHALE SPOUTING IN WATER WITH MOUNTAINS AT BACK) (DELETE RELISTED AS R-71)
R-70
12. CROOKED TREE I. P. A. (PIC OF TREE) (DARK HORSE BREWING MARSHALL MI)
13. SHIPYARD BREWING CO. PORTLAND MAINE / ESTABLISHED 1994 (ON OPENER BUTTON: THE SHIPYARD BREWING CO. EST. 1994)
14. SKAGWAY BREWING CO. EST. 1897 ALASKA
R-71
11. BUFFALO BILL'S BREWERY ALIMONY ALE (MAN SCREAMING LOGO)
12. DUST BOWL BREWING COMPANY * EST. 2009* * TURLOCK, CA* (BARBED WIRE LOGO) (BLACK WHITE ON RED)
13. FREMONT BREWING (PELICAN LOGO) FREMONT, EARTH
14. GOOSE (PIC OF GOOSE) ISLAND
15. PELICAN PUB & BREWERY PACIFIC CITY * OREGON COAST * USA (PELICAN IN LOGO)
16. SANTA CRUZ MOUNTAIN BREWING (PIC OF WHALE SPOUTING IN WATER WITH MOUNTAINS AT BACK)
17. VICTORY WHOLE FLOWER HOPS FOR FRESHNESS
R-96
2. FIFTY FIFTY BREWING CO. TRUCKEE CA (LOGO)
3. FOUNDERS BREWING CO. SINCE 1997 BREWED FOR US. ENJOYED BY EVERYONE. GRAND RAPIDS, MICHIGAN
4. FOUNDERS BREWING CO. SINCE 1997 BREWED FOR US. GRAND RAPIDS, MICHIGAN
5. LAURELWOOD BREWING CO. PORTLAND, OR (TREE LOGO)
6. MARBLE BREWERY (LOGO)
7. PLINY THE ELDER
8. PYRAMID BREWERIES (PYRAMIDS LOGO)
9. SHINER PREMIUM BEER (LOGO WITH STATE OUTLINE)
R-97
6. DROP TOP AMBER ALE (WIDMER PRODUCT) (WITH DOG HEAD IMAGE REPEATED 10 TIMES WITH A G-117 (BLANK) ATTACHED)
7. THIRSTY DOG GREEN ON BLACK (PIC OF DOG HEAD & MUG LOGO) (REPEATED 4 TIMES)
8. THIRSTY DOG GREEN ON BLACK (PIC OF DOG HEAD & MUG LOGO) (REPEATED 4 TIMES)
9. TROEGS BREWERY (REPEATED 10 TIMES)
R-98
BASKETBALL/CAP LIFTER
MADE OF PLASTIC WITH METAL INSERT CAP LIFTER
(SEE R-34)
1 3/4"
MIKE KREJCI

- 1. BUD (C LOGO) LIGHT MARCH TO THE CHAMPIONSHIP
(IN LOGO) (BLUE ON TAN)
R-99
BELT CLIP/CAP LIFTER
4 1/4"
ART SANTEN
- 1. BUD (C LOGO) (WHITE ON BLUE)
R-100
CHA CHA/CAP LIFTER
(SEE R-45)
4 1/4"
MIKE KREJCI
- 1. BUD (C LOGO) LIGHT
R-101
LIFE PRESERVER/CAP LIFTER
2 3/4"
MIKE KREJCI
- 1. (C LOGO) BUD LIGHT (C LOGO) BUD LIGHT
R-102
SANDAL/CAP LIFTER
METAL BOTTOM
(SEE R-89)
5 1/8"
MIKE KREJCI
- 1. (C LOGO) BUD LIGHT
R-103
CHAIN/CAP LIFTER
HEAVY METAL
4 1/2" TO 5 3/4"
TODD BARNES/JOHN CARTWRIGHT
- 1. (2 RED STRIPES) (SKA BREWING CO) (RED ON WHITE)
- 2. SKA / SKA (DURANGO CO MICRO) (WHITE ON BLACK)
R-104
HORSE HEAD/CAP LIFTER
1 3/4" TO 2 1/4"
MIKE KREJCI
- 1. KENTUCKY ALE (WHITE ON BLACK)
- 2. KENTUCKY ALE / GO BIG BREW (WHITE ON BLUE)
(COMES IN 2 SIZES)
- 3. ROLLING ROCK (WHITE ON GREEN)
R-105
SURFBOARD LEANING ON POST/CAP LIFTER
MADE IN CHINA
5 1/2"
MIKE KREJCI
- 1. LANDSHARK PREMIUM QUALITY LAGER ORIGINAL ISLAND LAGER (PIC OF SHARK FIN IN FRONT OF AN ISLAND) MARGARITAVILLE HEMISPHERE DANGER (IN LOGO) FINS UP / FINS TO THE LEFT...FINS TO THE RIGHT MARGARITAVILLE BREWING COMPANY
R-106
MUDSHARK/CAP LIFTER
METAL BOTTOM
(SEE R-17 & R-58)
3"
TODD BARNES/BRIAN COOLEY
- 1. MUDSHARK BREWERY / LAKE HAVASU CITY, AZ (WHITE ON BLACK)
R-107
JERSEY/CAP LIFTER
MAGNET ON BACK
MADE IN CHINA
4 1/2"
MIKE KREJCI
- 1. PACKERS (G LOGO) / BUDWEISER (CROWN LOGO) KING OF BEERS
R-108
COASTER/CAP LIFTER
3 1/2"
MIKE KREJCI
- 1. THE ORIGINAL TWISTED TEA HARD ICE TEA 5% ALCOHOL BY VOLUME BE A LITTLE TWISTED

- X-23
2012 JFO CONVENTION OPENER
"CASINO CHIP SHAPED"
3"
JOHN CARTWRIGHT/JOHN STANLEY
- 1. 34TH JUST FOR OPENERS CONVENTION DRINK RENO BEER LAS VEGAS, NV APRIL 18-22, 2012 THE PALMS CASINO RESORT (JUST FOR OPENERS J. F. O. IN FLAG LOGO) (2 VAR (A) BRASS (B) CHROME)
Z-1
 - 3. CREMO BEER ALE (WHITE ON GREEN)

A SINCERE THANK YOU TO THE FOLLOWING DEVOTED COLLECTORS WHO TOOK THE TIME TO SEND THEIR NEW ADDITIONS (UL'S) TO ME TO MAKE THIS LIST POSSIBLE. IT IS GREATLY APPRECIATED BY ALL MEMBERS.

MEMBER NAME & NUMBER (# LISTED)

TOM BALANDA JR 1061 (8)
TODD BARNES 1153 (15)
KEITH BROWN 1062 (1)
DON BULL 1 (1)
JOHN BURRUSS III 822 (3)
JOHN CARTWRIGHT 587 (66)
BRIAN COOLEY 1163 (20)
EBAY 0 (40)
JOHN EBLEN 1149 (26)

JOHN FISHER 865 (20)
JACK FORD 8 (1)
CRAIG GREEN 187 (1)
BEN HOFFMAN 261 (30)
DAVID HERRIGAN 1078 (3)
NORM JAY 181 (1)
JIM KAISER 893 (1)
MIKE KREJCI 909 (5)
DAVE LENDY 804 (1)
GREG LOY 752 (11)
LARRY MOTER 450 (4)
JIM OSBORN 126 (1)
KEN OSTROW 800 (3)
ART SANTEN 158 (48)
PAT STAMBAUGH 930 (3)
DARVIN STIWELL 980 (2)
JOHN STANLEY 339 (53)
VERNE VOLLRATH 162 (4)
SCOTT WILLIAMS 365 (3)
KEN WISKUS 1150 (1)



Two different RARE wire bottle openers bought by Larry Moter this past six months on eBay. Above is the E-7-UL Niagara Falls and below is the E-9-UL Carson City. The rare ones still command big \$\$\$!



If anyone finds mistakes in the New Addition listings above please contact your editors. I do update the online newsletter when I know mistakes have been made. Thanks again to all who participate and share their new finds. John

“Opener and eBay Trivia” (“BIN” Buy-It-Now & “DNMR” Did Not Meet Reserve)

For this issue we have six quarters of eBay results and below are a few of the more interesting results. Ebay has continued it's transformation into an Amazon Auction House with collectibles almost falling into a nuisance category. All of their changes are geared towards retail sales from pricing to a feedback and refund system that totally favors the buyer. But even with these changes eBay remains the best place to sell openers. And as I have mentioned many times the last few years, the ICCA Auction has taken over the corkscrew market place (see ICCA Auction results at the end of the “Opener Trivia” section with prices realized being shown high to low amount).

A-001-035, Fitger Non-Alco, 6, \$112.51

A-004-UL, Rahr's Beer That Made Milwaukee Jealous, 6, \$102.50

A-013-UL, Here's How Ben E Meyer The Budweiser Man, 6, \$123.51

A-017-025, Mischicott (Glued to Board), 6, \$80.00

A-017-025, Mishicott, 6, \$157.50

A-028-006, Centennial (BIN), 6, \$199.95

A-028-006, Centennial, 8, \$224.50

A-028-022, Schaller, 8, \$166.38

A-028-022, Schaller Eclipse, 6, \$79.09

A-042-015, Davenport, 6, \$160.49

A-042-UL, Pfeiffer's Famous, 4, \$102.50

A-042-UL, Virginia Brewing Roanoke VA (DNMR), 4, \$155.00

A-999-999, (Car & Tree) Chevrolet (In Logo) / Kewanee Chevrolet (In Logo) Phone 1670, 4, \$169.49

A-999-CAN, Frontenac Beer Truck, 6, \$136.49

The A-1 Fitgers Beer without Non-Alco sells for a lot less than the example listed and those Non-Alco words sent this one very high. Rahr beer openers are popular and being unlisted added to the price in this one.

Your editor added the A-13 Budweiser car to my almost complete collection of beer cars (I need the two “F”s, Finks and Fredericksburg cars). I also added the A-17 Mishicott lion head opener after taking a gamble as it was “glued” to a board. A prior sale of the A-17 had sold for \$157.50. The gamble paid off but then \$80 is not cheap either.

Two different sales of the A-28-6 Centennial bottle shape with a gas key went very high. For beer openers it usually depends on the ad and some Montana collectors really wanted these openers. Same deal on the A-28 Schaller openers though not as crazy as the Centennial openers but some Cincinnati collectors bid heavy.

Three different sales of A-42 fish shaped openers saw

some high prices but with two of them being Unlisted and the Davenport was only the second one I have seen, the final values are not that out of line.

Finally for the “A” figurals, two different car/truck shaped openers were sold. The Chevrolet car is very desirable and has gone much higher than this one at \$169.49. The Frontenac truck from Canada is another very popular figurial. The final price of \$136.49 is not cheap but it is nice looking truck.

B-002-035, Husa, 6, \$202.50

B-002-035, Husa (BIN), 8, \$200.00

B-002-035, Husa Bangor, 6, \$137.50

B-002-035, Husa Bangor (BIN), 6, \$195.00

B-007-019, Bohrer, 6, \$155.55

B-018-217, Reisch, 4, \$284.00

B-018-568, Pechstein & Nagel, 6, \$238.50

B-018-599, Husa Bangor (BIN), 4, \$153.51

B-018-676, Boise, 4, \$66.01

B-018-676, Boise, 6, \$129.49

B-018-UL, John Walter Brewing Co Eau Claire Wis, 6, \$209.71

B-019-UL, John Hauck Brewing Cincinnati, 6, \$102.50

B-021-493, Owyhee (w/ Picnic Paper Package), 6, \$131.50

B-045-999, Denhalter Bottling Salt Lake City, 6, \$137.51

B-060-001, Bartl (BIN), 6, \$250.00

B-072-002, Old Colony, 6, \$262.55

One rumor we can put to rest is that a B-2-35 Huss is a rare opener. Four examples sell this past six months with the lowest result being \$137.50. The previous issue one had sold for \$350.00 and I would think by now anyone needing this opener would have it. The buttonhook B-7 Bohrer was a high price but many B-7s are very hard to find.

The B-18s were all rare openers and the prices realized show this. Like B-19s and B-21s the B-18s have prices from a \$1 to \$300 and everything depends on the brewery name. The B-21-493 Owyhee was neat with the original envelope and the final price of \$131.50 was not that crazy.

Another B-45 from Salt Lake City was sold and the salesman for this style worked almost entirely in this city. The lone known beer ad for Lemp Beer is from Salt Lake City and at least four other B-45s are from there. The B-60 Bartl was snapped up quickly with the Buy-It-Now and was from Verne's collection. I actually had an inquiry the next morning from a Wisconsin collector wanting to know why the listing had disappeared.

“Opener and eBay Trivia” (“BIN” Buy-It-Now & “DNMR” Did Not Meet Reserve)

At the 2008 JFO Convention in St. Louis I traded the only known at that time B-72-2 Old Colony to Jim Osborn. I did regret it later but was very happy when this second example appeared on eBay. The price was not cheap but now I have the B-72 set and the other B-72 from Chattanooga is reunited with her sister. Amazingly there are now two known sets of B-72s. I have one set and Jim Osborn has the other.

CBO-BB-19, Miller, Debrul & Peters Mfg, 8, \$67.98

CBO-HOR-05, Colon Mild Havana Cigars, 8, \$116.49

CBO's are really fun to collect and I have bought quite a few the last few years. I was able to buy the CBO-BB-19 and think it is the first time an actual one has been found as the CBO guide just shows a drawing. I was not so lucky on the CBO-HOR-05 and lost out to a Seattle collector. For the most part most CBOs sell for less than \$25 and like anything the harder to find styles bring more money.

D-001-032, Lange, 6, \$107.50

D-001-035, C&J Michel, 6, \$100.00

D-003-020, Miller, 6, \$111.00

D-003-020, Miller, 4, \$31.40

The first three sales were from Verne's collection as many “D” cast iron openers have been hot in the market place. I threw in a token bid for the D-3-20 Miller and won it at \$31.40. Like many things on eBay the prices are all over the place.

E-004-145, Senate, 6, \$117.50

E-004-999, (w/ Screwdriver Tip) William H Nobman The Winchester Store / Oyster Bay NY, 6, \$189.99

E-007-UL, Niagara Falls Brewing Spray Beer, 6, \$205.00

E-009-UL, Carson City Brewing Tahoe Beer, 6, \$202.19

A few really good wire examples are listed above with the E-4-145 Senate going over a \$100 and I am not sure why. A fairly hard to find opener but they do turn up. The E-4 Winchester opener was the first time I had seen this ad and the starting price was \$189.99 and I assume a Winchester collector bought it. I would call this a crazy price. It certainly caught my eye.

Larry Moter was on a roll buying two never seen before wires but he had to step up big time on both. Congratulations to Larry and the E-9 Carson City is the first opener with the brewery name on it that has been discovered (there are some Tahoe ad openers). Niagara Falls and Spray on the same opener (I believe one key style has both) made this one a hotly pursued by New York collec-

tors.

FBOC-024, Mexican Cactus (BIN), 8, \$175.00

FBOC-422, Amish Man, 6, \$500.00

Just a couple of the harder to find Cast Iron figural results are shown. Ebay always has lots of common and repros for sale. The Mexican Cactus is hard to find and would certainly have brought more a few years back but considering today's market the price of \$175 (Buy-It-Now) was jumped on by one collector.

One of the most desirable if not the most desirable figural bottle openers is the FBOC-422 Amish Man. I have mentioned before it was easily in the \$1,500-\$2,000 range at one time and once again \$500.00 is not that bad of a result as the condition on this one was just very good. If you like cast iron figurals now is a good time to buy but be very careful.

I-012-038, Hamms (Box of 500), 10, \$330.00

Another comment I have made before is the only thing worse than having a common opener is having a bunch of the same common opener! I keep assuming and in this case hopefully someone bought these for a giveaway somewhere. The seller had several boxes and this one brought the most.

M-002-012, Berry, 6, \$152.50

M-073-001, Missoula (Blue), 8, \$260.00

M-073-014, Budweiser Becker, 8, \$188.20

M-073-999, Electro-Chemical (Red), 6, \$255.69

M-154-001, Bridgeport (MIB), 10, \$240.75

One lithograph opener result and the M-2-12 Berry is hard to find and someone got a good buy. The M-73 corkscrew sliders saw lots of action the last two quarters and the results are in line with what they have been bringing with beer ads or if they are from the Electro-Chemical Co.

The M-154-1 Bridgeport is a nice heavy brass tap handle made in the last 10 years. Why it went crazy I am not sure. Granted you do not see them for sale very often but multiple people went crazy chasing this one. I had one extra and sold it for \$25 (what I thought was the going price) in 2010 and then later sold another one for \$40 (what the brewery sold them for with shipping).

N-029-999, Drink Coca-Cola In Bottles Pure As Sunlight, 8, \$256.07

Coca-Cola pencil types whether they are the N-22 or N-29 the price goes way up. N-22s have brought over \$500 and this N-29 had a lot of attention before closing at \$256.07. For Coca-Cola collectors not a big price but pretty serious

“Opener and eBay Trivia” (“BIN” Buy-It-Now & “DNMR” Did Not Meet Reserve)

money for sure.

- O-001-UL, Walters Eau Claire Wisc, 8, \$293.00**
- O-006-999, Donald Duck (Pic of Donald Duck) Soft Drinks, 10, \$283.00**
- O-006-UL, Krueger's Beer & Ale, 8, \$231.61**
- O-012-001, Pabst, 6, \$255.00**
- O-502-999, Coca-Cola, 6, \$430.99**
- O-502-999, Coca-Cola (Covered in White Paint), 2, \$359.44**
- O-509-999, Dr Pepper, 8, \$359.00**

Many wall mount types in this group and our Erickson sellers have been going strong. I keep mentioning someone must have found the Erickson archives as they are offering so many never seen before wall mounts. The one common factor is the thick enamelling and not like your usual standard O-2 or O-6. If someone is making these up they have a great imagination. There are a lot of great ads on them with most being soda brands.

The O-1 wall mount type is one I have several of and wanted the Walters. I figured \$150.00 would cover it and was a distant fourth place. The final price was unreal but a very serious Walters collector won the opener.

The O-12 Pabst brought a fair price at \$255.00. It has sold anywhere from \$150-\$400 in the past. The two O-502 Coca-Cola side wall mounts were very sought after by the Coca-Cola and wall mount collectors. The one with white paint was very surprising for what it brought considering condition. The O-509 Dr. Pepper went very high but the style, a Deluxe De-capper, with a nice full decal sent the price that high and being Dr. Pepper helped also.

P-009-022, Virginia, 6, \$240.06

P-026-017, Bergner & Engel, 8, \$333.00

Just a couple of the many beer advertising corkscrew results. The P-9 Virginia was in nice condition and items from the Roanoke, Va. Brewery are very popular with collectors. The Bergner & Engel knife was in great shape and ending price was fairly high but condition won out. There were numerous Anheuser-Busch knife sales the last six months but none that were real exciting. The A-B knives just keep turning up in numbers.

R-008-001, Kaier (FBOC-405 Miner), 6, \$350.00

Another one time very desirable cast iron opener from Verne Vollrath's collection. Just a few years back I paid \$350 for mine and was very happy to get it at that price. Today \$350 is on the high end and I keep thinking just how low can cast iron prices go.

Z-Corkscrew, English 19thC BB Wells Winged Nut, 8, \$3,857.66

Z-Corkscrew, French 1830 Deleuz Champagne Tap Patent (Ornate), 8, \$2,800.00

Z-Corkscrew, German 1882 Valentin-Rasch Patent # 20,803, 8, \$4,184.78

In my opening statements I mentioned that the ICCA Auction has taken the lead in selling quality corkscrews but a few good pieces still show up on eBay. Three of the best are shown above and usually the better ones are foreign. The good American corkscrews are listed with the ICCA.

Ebay is still a great place to find good openers and in fact is much better than any other arena. Unless you buy a collection or come to the JFO Convention you would be hard pressed to find quality openers at one time anywhere else. Comments from members are welcomed.



Don Bull showed this ad in an early JFO Newsletter (Oct/1981) for a generic K-16.

The ad at left is from the October, 1936 issue of Modern Brewery Age magazine. The Type I-24 combination can piercer / cap lifter shown is marked "PorEzy Patd." Has anyone found out if a patent was indeed issued for this opener? Has anyone seen the K-type can piercer with beer advertising shown in this ad? Without adv.? (Ad courtesy of Bill Vollmar, Anheuser Busch achivist).

“Opener and eBay Trivia” (“BIN” Buy-It-Now & “DNMR” Did Not Meet Reserve)

A-001-002, Aurora, 6, \$41.41	A-004-999, Drink Mint Cola, 6, \$46.89	drich Phila, 4, \$21.50	6, \$81.00
A-001-002, Aurora, 4, \$42.41	A-004-999, Mohr Bros Toledo OH, 6, \$29.99	A-009-999, Schusters Root Beer, 4, \$22.50	A-017-999, Coca-Cola In Bottles, 6, \$79.00
A-001-004, Crystal Rock, 6, \$15.00	A-004-UL, Hoster's For Health, 6, \$36.00	A-010-001, Muehlebach, 6, \$91.00	A-017-999, Gold Sun Coffee, 4, \$19.99
A-001-005, Excelsior, 6, \$43.51	A-004-UL, Rahr's Beer That Made Milwaukee Jealous, 6, \$102.50	A-012-010, Becker, 8, \$27.00	A-017-999, Jim Dybala Bottling Co Woonsocket RI, 6, \$51.00
A-001-016, Montana, 6, \$35.00	A-005-001, Golden Ribbon, 6, \$18.00	A-012-014, Rahr, 6, \$40.00	A-018-003, Star, 8, \$49.95
A-001-022, Fresno, 6, \$28.05	A-005-008, Utica-Club, 6, \$18.00	A-012-016, Tivoli, 8, \$8.50	A-018-008, Budweiser, 8, \$40.00
A-001-022, Fresno Clothed, 6, \$10.51	A-005-009, Columbia Malt, 6, \$18.00	A-012-017, Maier, 6, \$26.00	A-018-020, Fisher, 6, \$67.99
A-001-025, Lembeck & Betz, 6, \$57.24	A-005-011, Jones, 6, \$47.46	A-012-999, Airship Akron Souvenir, 6, \$31.00	A-020-003, Hofbrau, 6, \$16.50
A-001-028, Yosemite, 4, \$40.99	A-005-018, Flecks Beverages, 6, \$31.11	A-012-999, US Airship Akron, 6, \$34.00	A-020-015, Amsterdam, 6, \$20.50
A-001-035, Fitger Non-Alco, 6, \$112.51	A-005-020, Standard Malt, 6, \$18.00	A-012-999, USS Akron Souvenir, 6, \$30.00	A-020-016, Century, 6, \$13.66
A-001-048, Sebewaing, 4, \$20.50	A-005-025, Eastside, 8, \$47.00	A-013-000, Lemp Var C, 4, \$27.87	A-020-016, Century, 8, \$20.00
A-001-048, Sebewaing, 6, \$25.25	A-005-025, Eastside, 8, \$46.89	A-013-006, Lemp Var C (Screwdriver Tip Filed), 4, \$54.00	A-020-019, Eifenbrau, 8, \$34.33
A-001-049, Home Meister Brau, 8, \$32.05	A-005-028, Milwaukee Cream, 6, \$20.59	A-013-999, Florissant Filling Station 2117 Palm St. Owners No. 325, 6, \$32.35	A-020-019, Goetz, 6, \$21.53
A-001-049, Meister Brau, 6, \$23.00	A-005-031, Terre Haute, 6, \$42.99	A-013-999, Frank & Ernest Garage Nashua NH Owners No 67, 4, \$31.01	A-020-023, Kochs, 8, \$37.00
A-001-050, Old Style, 8, \$21.04	A-005-033, OK Extract, 6, \$9.10	A-013-999, Hunter's Home Saloon Grand Rapids MN, 6, \$41.00	A-020-024, Belmont, 6, \$26.00
A-001-053, Leisy, 6, \$21.00	A-005-036, Main Malt, 6, \$9.99	A-013-999, J N Hance Hay, Grain, Cola Etc, 6, \$18.50	A-020-026, Phoenix, 8, \$77.60
A-001-053, Leisy, 6, \$29.99	A-005-042, Williams Malt, 6, \$26.50	A-013-999, Peral River Auto Co Buick Cars, 6, \$34.25	A-020-034, Peerless, 8, \$23.05
A-001-063, Union Malt, 6, \$18.50	A-005-045, Zahringer Fossco Malt, 6, \$20.52	A-013-999, Storz Auto Supply Omaha, 6, \$15.50	A-020-040, Old Germania, 6, \$36.05
A-001-064, Great Falls, 8, \$17.65	A-005-049, York, 2, \$31.00	A-013-999, The Budweiser Man, 6, \$123.51	A-020-044, Seitz, 6, \$20.00
A-001-064, Great Falls, 6, \$27.50	A-005-050, Falls City Beverages, 6, \$21.28	A-015-005, Schreier, 6, \$20.49	A-020-999, Orange Crush (w/ C-13 Orange Crush), 6, \$27.99
A-001-068, Liberty, 6, \$36.88	A-005-056, Schmidt Products, 6, \$18.00	A-015-005, Schreier, 6, \$14.48	A-021-002, Blatz, 6, \$22.50
A-001-075, Fink Var A, 6, \$46.88	A-005-057, South Bend Malt, 6, \$17.51	A-015-005, Schreier, 6, \$25.10	A-021-009, Walters, 6, \$31.05
A-001-076, Gettelman, 6, \$40.00	A-005-057, South Bend Malt, 6, \$18.00	A-015-005, Schreier, 8, \$30.00	A-021-012, Consumers, 8, \$33.55
A-001-080, Montana, 6, \$24.50	A-005-060, Greenfield Malt, 6, \$18.00	A-015-008, Fortune Bros, 6, \$21.49	A-021-014, Leidigers, 8, \$25.00
A-001-080, Montana Var A, 6, \$34.57	A-005-066, South Side Malt, 6, \$36.01	A-015-015, South Bend Golden, 6, \$37.01	A-021-016, Atlas or Kingsbury, 8, \$16.95
A-001-999, Drink Quako, 8, \$27.56	A-005-072, Hickman Malt, 6, \$18.00	A-015-019, Fremont, 6, \$15.50	A-021-017, Blatz, 6, \$12.62
A-001-999, Nu Grape, 6, \$20.00	A-005-072, Jakes Masterbru, 6, \$18.50	A-015-019, Fremont (Script), 6, \$16.39	A-021-024, Gambrinus, 6, \$27.75
A-001-999, Zeisler Bottling Works St Charles MO, 6, \$25.00	A-005-101, Masterbru, 6, \$18.00	A-015-025, Schwab, 4, \$28.00	A-021-026, Hoch Brau, 8, \$28.99
A-001-CAN, Copeland's Ale Lager, 6, \$14.50	A-005-103, Tip-Top Malt, 6, \$18.00	A-015-026, South Bend Tiger Brew, 6, \$26.52	A-021-032, Grossvater, 6, \$9.99
A-001-UL, Stone Malt Co Canton OH, 6, \$36.55	A-005-999, Amico's Pale Dry Ginger Ale, 8, \$49.45	A-015-035, Crown, 8, \$79.99	A-021-039, Foss-Schneider, 6, \$44.98
A-002-999, Bob's Tavern Smeltonville Idaho, 6, \$34.99	A-005-999, Whistle Lansford PA, 6, \$34.33	A-015-036, Interstate, 6, \$27.00	A-021-057, Sunbury, 6, \$41.00
A-002-999, Electric Beverage Co. Beer By The Case To Go, 6, \$13.63	A-006-001, West End, 6, \$15.49	A-015-036, Nulife, 8, \$56.51	A-021-065, Farmers, 8, \$22.50
A-003-002, Jiffy Brumalt, 6, \$16.17	A-006-001, West End, 8, \$15.50	A-015-044, Interstate, 8, \$32.60	A-021-065, Farmers, 8, \$25.00
A-003-007, Jiffy Brumalt, 6, \$19.05	A-006-001, West End, 6, \$22.99	A-015-051, Cooks, 4, \$12.99	A-021-074, Hamms, 6, \$41.00
A-003-008, Jiffy Malt, 6, \$15.00	A-007-013, Mohawk, 6, \$20.00	A-015-078, Birk Bros, 6, \$51.66	A-021-075, Engesser, 6, \$52.28
A-003-012, Stone Malt, 6, \$22.99	A-007-013, Mohawk, 6, \$22.72	A-015-999, 1934 Chicago WFs (Button), 8, \$25.00	A-021-092, Lone Star, 6, \$39.00
A-003-013, Stone Malt, 6, \$16.26	A-007-013, Mohawk, 6, \$17.28	A-016-005, Gold Top, 6, \$40.00	A-021-093, Piels, 8, \$41.00
A-003-016, Homa Malt, 6, \$16.75	A-007-017, Gin's Malt, 6, \$16.00	A-016-999, H C Breimeyer Bottling St Louis, 6, \$20.00	A-021-104, Pabst, 6, \$34.33
A-003-020, Hart Malt, 6, \$16.75	A-007-021, Manhattan Bottling, 8, \$15.00	A-016-999, Herbola, 6, \$14.50	A-021-128, Hamms, 8, \$16.16
A-003-021, Klasko Malt, 6, \$15.50	A-007-022, Schlitz, 6, \$20.00	A-016-999, Warwick Bottling Artic RI, 6, \$74.42	A-021-155, Schmidts Coca-Cola, 6, \$50.00
A-003-025, Home Products, 6, \$12.49	A-007-023, Marx Malt, 6, \$16.00	A-016-CAN, Adanac, 6, \$28.60	A-021-158, Narragansett, 8, \$25.28
A-003-025, Home Products Malt, 6, \$20.63	A-007-050, Great Falls, 6, \$20.68	A-016-CAN, Adanac Beer, 4, \$7.50	A-021-158, Narragansett, 8, \$10.00
A-003-026, Jiffy Malt, 6, \$23.02	A-008-001, Ruppert, 4, \$24.50	A-016-CAN, Heuther Brewing, 6, \$13.50	A-021-159, Ruppert, 8, \$33.55
A-003-041, Beloit Malt, 6, \$16.75	A-008-001, Ruppert, 6, \$20.50	A-016-CAN, Moose Jaw Brewing, 6, \$18.50	A-021-167, Miller, 8, \$39.99
A-003-046, Beloit Malt, 6, \$15.00	A-008-001, Ruppert, 6, \$23.27	A-017-011, Cream City, 6, \$26.52	A-021-999, Coca-Cola (Block) Tell City IN, 8, \$69.00
A-003-UL, Jiffy Malt J Baratonna Dist Trinidad Colo, 4, \$20.50	A-008-001, Ruppert, 6, \$16.49	A-017-011, Cream City, 6, \$26.75	A-021-999, Fowler Hotel Fowler MI, 6, \$36.79
A-004-003, Cascade, 6, \$43.99	A-008-001, Ruppert, 6, \$20.50	A-017-014, Capital City, 6, \$41.01	A-021-999, Indian Motorcycles Jax FL, 4, \$15.50
A-004-004, Clinton, 4, \$25.00	A-009-001, Buffalo (w/ Buffalo B-19-5, B-24-4, E-4-16), 6, \$51.00	A-017-023, Luxus, 6, \$20.00	A-021-999, Take A Spin on a Whizzer Clark's Indian Cycle Co Charle-roi PA Bicycles-Service, 6, \$39.88
A-004-004, Pointer, 4, \$27.00	A-009-003, Hoster, 6, \$31.51	A-017-023, Luxus, 6, \$25.00	A-021-999, The Club Chateau Garden Finest Music In Town San Pedro CA, 6, \$77.26
A-004-009, Leisy, 6, \$10.50	A-009-003, Hoster, 6, \$45.00	A-017-025, Mischicott (Glued to Board), 6, \$80.00	A-021-MEX, Cerveza Mexicali, 6, \$14.55
A-004-010, Star, 4, \$25.00	A-009-003, Hoster, 6, \$46.00	A-017-025, Mishicott, 6, \$157.50	A-021-UL, Becker's Best Beer Old Faithful Beverage Co Idaho Falls ID, 8, \$66.00
A-004-011, Popel-Giller, 6, \$38.11	A-009-004, Leisy, 4, \$10.50	A-017-029, Fresno, 6, \$50.99	A-021-UL, Country Club Beer Kearney NE, 6, \$29.99
A-004-011, Popel-Giller, 4, \$25.00	A-009-004, Leisy, 8, \$15.50	A-017-050, Golden Eagle Dutch Malt,	A-021-UL, Keeley Half & Half Rockford IL, 6, \$23.50
A-004-013, Akron, 6, \$22.50	A-009-006, San Pedro Wholesale, 6, \$29.99		A-023-005, Heidel-Brau, 8, \$33.00
A-004-013, Akron, 6, \$20.00	A-009-008, Kamm & Schellinger (w/ B-14-30 K & S), 6, \$37.99		A-023-009, Grain Belt, 8, \$34.99
A-004-013, Akron, 6, \$31.00	A-009-012, Ringler Var B, 4, \$16.50		A-023-999, Coca-Cola, 8, \$28.00
A-004-015, Leisys, 6, \$22.98	A-009-017, Schells, 6, \$33.50		A-023-999, Coca-Cola, 8, \$21.83
A-004-017, Alpen Brau Var B, 6, \$23.50	A-009-017, Schells, 6, \$71.00		A-023-999, Coca-Cola, 8, \$48.00
A-004-022, Falls City, 6, \$26.00	A-009-028, Haffenreffer, 4, \$16.50		A-024-999, NuGrape, 6, \$13.99
A-004-022, Falls City, 8, \$20.50	A-009-999, Carragien's Bar El Paso TX, 6, \$29.50		A-025-009, Edelweiss, 4, \$18.50
A-004-022, Falls City, 6, \$30.00	A-009-999, Drink Whistle John Frie-		A-025-009, Schoenhofen, 6, \$24.99
A-004-027, Highland, 6, \$15.55			
A-004-035, KK Beer, 4, \$31.00			
A-004-043, Reading, 6, \$19.99			
A-004-057, Oertel, 6, \$25.00			
A-004-999, Appleton Bottling Works Appleton Minn, 6, \$34.69			
A-004-999, Chero Cola, 6, \$15.50			
A-004-999, Chero-Cola 5c, 6, \$19.95			
A-004-999, Delicio, 4, \$16.00			

“Opener and eBay Trivia” (“BIN” Buy-It-Now & “DNMR” Did Not Meet Reserve)

A-025-009, Schoenhofen, 2, \$20.69	House Havre MT, 6, \$29.99	B-003-004, Edelweiss, 8, \$39.00	B-018-020, Dawson, 8, \$24.38
A-025-009, Schoenhofen, 8, \$23.38	A-041-001, Medford, 6, \$51.00	B-003-004, Edelweiss (6 Sold w/ Each at Price Listed BIN), 6, \$23.00	B-018-021, Dicks, 6, \$23.00
A-026-001, Empire, 6, \$28.09	A-042-006, Gold Top, 6, \$42.00	B-004-002, Scheidt, 6, \$18.50	B-018-024, Dubuque, 6, \$22.84
A-026-001, Empire, 6, \$17.50	A-042-007, Hoster-Columbus, 6, \$29.99	B-004-002, Valley Forge, 6, \$24.99	B-018-026, Enterprise, 6, \$22.16
A-026-003, Schoenhofen, 4, \$17.38	A-042-012, Pride of the Valley Malt, 6, \$23.50	B-005-003, Palouse, 6, \$50.00	B-018-027, Eulberg Var B, 6, \$30.00
A-028-002, Consumers, 8, \$62.65	A-042-012, Pride of Valley Malt, 4, \$43.00	B-005-004, Reno, 6, \$104.49	B-018-029, Fresno Clothed, 6, \$20.20
A-028-002, Consumers, 8, \$63.65	A-042-014, McInnery, 6, \$40.00	B-005-006, Storz, 8, \$20.00	B-018-038, Horlacher, 6, \$9.38
A-028-003, Deppen, 6, \$15.00	A-042-015, Davenport, 6, \$160.49	B-005-021, Broadway, 6, \$27.90	B-018-052, Pacific Club, 6, \$47.76
A-028-006, Centennial (BIN), 6, \$199.95	A-042-016, Port Washington, 8, \$40.00	B-005-026, Republic, 6, \$40.00	B-018-098, California, 6, \$18.00
A-028-006, Centennial, 8, \$224.50	A-042-999, Brown & Musselman Fishing Tackle, 4, \$21.50	B-005-031, Royal, 2, \$36.52	B-018-095, Century, 6, \$12.00
A-028-009, Flower City, 4, \$49.67	A-042-UL, Virginia Brewing Roanoke VA (DNMR), 4, \$155.00	B-005-046, National, 4, \$41.01	B-018-119, Schwarzenbach, 8, \$77.99
A-028-011, Franklin, 6, \$25.24	A-044-001, Cream City, 6, \$27.04	B-006-007, Furniture City, 6, \$51.00	B-018-120, Schwarzenbach, 4, \$22.00
A-028-019, Ryan, 6, \$62.65	A-044-003, Schmidt, 6, \$26.52	B-006-021, Hastings, 6, \$24.19	B-018-123, Standard, 6, \$36.00
A-028-019, Ryan, 4, \$63.65	A-044-999, C&R Bottle Co, 6, \$25.49	B-006-027, Neuweiler (BIN), 6, \$65.00	B-018-137, Franz Bros, 6, \$25.00
A-028-019, Ryans, 4, \$16.26	A-045-999, (w/ A-999 Pregnant Woman) (Brass), 8, \$54.00	B-007-015, B & O, 4, \$66.00	B-018-163, Columbia, 6, \$31.05
A-028-021, Haffenreffer, 6, \$15.00	A-045-999, Majestic Bar Butte MT, 6, \$42.00	B-007-016, Jetters, 6, \$46.00	B-018-166, Crown, 6, \$39.00
A-028-021, Hams, 4, \$40.00	A-053-999, Drink Cascade Ginger Ale, 6, \$10.51	B-007-017, Bohrer, 6, \$155.55	B-018-170, Diehl, 6, \$23.25
A-028-022, Schaller, 8, \$166.38	A-057-999, Fladung Beverages, 6, \$45.01	B-007-021, Gluek, 4, \$46.00	B-018-170, Diehl, 8, \$21.84
A-028-022, Schaller Eclipse, 6, \$79.09	A-073-001, Miller, 8, \$34.00	B-008-001, Crystal Rock, 6, \$6.25	B-018-174, Eastside, 6, \$20.49
A-028-027, Davenport, 6, \$40.00	A-504-999, Orange Crush, 6, \$25.00	B-008-004, Home Rule Malt (w/ B-18-520 Pilsener B-19-82 Galion B-22-88 Minneaplois & 3 Misc), 6, \$32.79	B-018-193, Imperial, 6, \$51.01
A-028-CAN, Dominion Brwery White Label Beer, 6, \$9.99	A-509-999, Nehi, 6, \$9.95	B-008-009, Woolner, 6, \$16.10	B-018-193, Imperial Pilsener, 6, \$36.00
A-029-014, Potosi, 6, \$25.00	A-509-999, Nehi, 6, \$20.50	B-008-999, L F Grammes & Sons, 6, \$16.10	B-018-204, Paducah, 6, \$32.69
A-029-015, Schneider, 6, \$15.00	A-509-999, Nehi 5c (Fantasy), 6, \$23.56	B-008-999, Wohlers Carbonated Beverages Mendota IL, 6, \$15.50	B-018-209, Iron City, 6, \$20.49
A-029-046, Oshkosh, 6, \$18.38	A-509-999, Nehi 5c (Fantasy), 6, \$51.00	B-009-999, El Mara 5c Cigars, 6, \$19.47	B-018-212, Portland, 6, \$11.38
A-029-051, Kiewel, 6, \$32.00	A-999-999, (Car & Tree) Chevrolet (In Logo) / Kewanee Chevrolet (In Logo) Phone 1670, 4, \$169.49	B-013-007, Haberer, 6, \$20.20	B-018-217, Reisch, 4, \$284.00
A-029-051, Kiewel, 6, \$29.50	A-999-999, Goodyear Airplane, 8, \$28.27	B-013-027, Elk (Opener Hook Missing), 2, \$25.99	B-018-219, Rainier, 6, \$18.89
A-029-051, Kiewel, 6, \$26.02	A-999-999, Goodyear Airplane, 8, \$29.99	B-013-050, Heileman (w/ Heileman Fob), 6, \$60.00	B-018-222, Schells, 6, \$90.00
A-029-052, Independent, 6, \$15.00	A-999-CAN, Frontenac Beer Truck, 6, \$136.49	B-013-056, R&H, 4, \$12.50	B-018-233, Gold Label, 4, \$10.99
A-029-065, Widmans, 8, \$66.55	B-001-001, Ben Brew (BIN), 4, \$125.00	B-013-059, Yough, 8, \$38.53	B-018-245, Bartels, 6, \$15.00
A-029-065, Widmans (BIN), 8, \$39.99	B-001-005, Pittsburgh Brass, 4, \$27.89	B-013-087, F&S, 6, \$12.99	B-018-257, Commonwealth, 6, \$15.00
A-029-999, Anton Cermak for US Senator, 6, \$17.00	B-001-006, Wagner (BIN), 2, \$27.50	B-014-005, Blatz, 8, \$10.01	B-018-260, Croak, 6, \$24.38
A-029-999, Carthage Bottling Works Carthage MO, 6, \$12.00	B-001-007, Welz & Zerweck, 8, \$103.00	B-014-012, E B Blue Star, 6, \$9.36	B-018-266, East Side, 6, \$30.00
A-029-999, Delaware Punch, 6, \$18.49	B-001-022, Portsmouth, 4, \$77.00	B-014-012, E B Blue Star, 6, \$15.73	B-018-267, Eureka, 4, \$40.00
A-029-999, Dr Pepper, 6, \$47.66	B-001-028, Reno (No Paint), 4, \$80.99	B-014-018, Hauenstein, 6, \$15.00	B-018-271, Gambrinus, 4, \$12.00
A-029-999, Dr Pepper, 6, \$33.76	B-002-001, Blatz (Brass), 6, \$64.00	B-014-043, South Fork, 6, \$24.49	B-018-273, German-American, 6, \$92.85
A-029-999, Dr Pepper (Spinner), 6, \$34.33	B-002-001, Blatz (Steel), 4, \$15.00	B-014-044, Walters, 6, \$9.99	B-018-282, Indianapolis, 6, \$9.99
A-029-999, Orange Crush, 6, \$24.00	B-002-001, Blatz (Var A) (w/ B-18-132 Blatz), 6, \$33.50	B-014-069, Pickwick, 6, \$45.51	B-018-288, National, 6, \$33.00
A-029-999, Pepsi=Cola 5c, 6, \$24.95	B-002-004, Feigenspan, 4, \$37.56	B-014-073, Atlas, 6, \$15.00	B-018-326, Bellingham Bay, 6, \$50.00
A-029-999, Pepsi=Cola 5c, 6, \$23.52	B-002-005, Fresno, 6, \$35.00	B-014-078, Bub, 4, \$16.10	B-018-334, Schaller Banquet, 6, \$29.00
A-029-999, Pepsi=Cola 5c, 6, \$32.01	B-002-010, Mission, 6, \$76.75	B-014-084, Gipps, 6, \$25.00	B-018-336, Lexington, 4, \$40.00
A-029-999, Pepsi=Cola 5c, 6, \$45.00	B-002-012, United States, 6, \$36.88	B-014-095, Hosters, 6, \$36.50	B-018-338, National, 6, \$11.10
A-029-999, Pepsi=Cola 5c, 6, \$32.27	B-002-014, Lone Star, 4, \$106.19	B-014-106, Cerva, 6, \$16.83	B-018-339, North Yakima, 6, \$27.00
A-029-999, Star Bottling Works Richmond VA, 4, \$35.00	B-002-016, Phoenix, 4, \$20.50	B-014-106, Hoster, 6, \$12.12	B-018-356, Goenner & Co, 6, \$30.00
A-029-999, Sunset Club Ginger Ale, 6, \$31.00	B-002-017, Southern Select, 4, \$24.95	B-014-156, Montana, 6, \$38.50	B-018-366, Imperial, 6, \$40.00
A-029-999, Try-Me Beverages, 6, \$15.15	B-002-023, Hazelwood, 6, \$51.00	B-014-175, Chicago WFs, 8, \$10.07	B-018-370, Kessler, 6, \$51.66
A-030-003, Leinenkugel, 4, \$127.50	B-002-024, Iroquois Indian, 8, \$103.50	B-014-999, 1933 Chicago WFs, 8, \$10.07	B-018-372, Mouls, 6, \$40.05
A-030-004, Schotts, 6, \$34.99	B-002-030, Hanley, 2, \$47.79	B-014-999, Coca-Cola Bottling Co Bloomington-Indiana, 6, \$128.38	B-018-372, Mouls, 2, \$26.60
A-030-999, Havens Golden Rod Ginger Ale Westerly RI, 6, \$30.99	B-002-034, Rainier, 4, \$26.15	B-014-999, Coca-Cola Okmulgee OK, 6, \$26.56	B-018-382, Whitewater, 6, \$15.15
A-032-003, Wooden Shoe, 8, \$15.55	B-002-035, Hussa, 6, \$202.50	B-014-999, Indianapolis Motor Speedway (On Badge), 8, \$76.00	B-018-405, Bartels, 6, \$25.00
A-033-999, Jake's Club Rice Lake WI, 8, \$26.69	B-002-035, Hussa (BIN), 8, \$200.00	B-014-999, Pepsi=Cola Genoa Bros, 8, \$67.00	B-018-410, Croak, 6, \$28.88
A-034-003, Gilt Top, 8, \$60.00	B-002-035, Hussa Bangor, 6, \$137.50	B-014-999, Pepsi=Cola Genoa Bros Humboldt NE, 6, \$46.00	B-018-414, Fountain City, 2, \$67.00
A-034-999, J C Yokel Hardware Friend Neb, 8, \$22.48	B-002-035, Hussa Bangor (BIN), 6, \$195.00	B-014-CAN, Calgary Brewing & Malting, 6, \$15.00	B-018-416, Graf Bros, 6, \$50.00
A-035-005, Buffalo, 6, \$22.50	B-002-036, Wagner (BIN), 6, \$44.00	B-014-CAN, Drewry's Beer Ale Stout Winnipeg, 6, \$49.99	B-018-426, Roseneck, 6, \$36.87
A-035-005, Buffalo, 8, \$27.09	B-002-042, Lone Star, 4, \$96.00	B-014-UL, Hoster Columbus Hos=Colo Cola, 4, \$12.72	B-018-443, Bavarian, 6, \$26.00
A-035-005, Buffalo Var B, 6, \$15.50	B-002-999, Coca-Cola, 2, \$28.00	B-015-005, Gold Vond, 4, \$15.00	B-018-463, Celilo, 6, \$30.00
A-035-008, Leisy, 6, \$20.00	B-002-999, Coca-Cola Brass, 2, \$48.00	B-017-004, Centennial, 6, \$63.65	B-018-512, Jamestown, 6, \$30.00
A-035-010, Star, 6, \$41.00	B-003-004, Edelweiss, 6, \$35.55	B-017-008, Walter (w/ Horix Cork-screw & 38 Misc), 6, \$85.04	B-018-520, Pilsener (w/ B-8-4 Home Rule B-19-82 Galion B-22-88 Minneaplois & 3 Misc), 6, \$32.79
A-035-010, Star, 6, \$45.78		B-017-UL, Evansville Brewing Assn, 6, \$39.41	B-018-525, Willow Springs, 6, \$25.00
A-035-018, Walla Walla, 6, \$40.00		B-018-006, Berkshire, 6, \$23.73	B-018-538, American, 6, \$15.00
A-035-019, Weibel, 6, \$35.00		B-018-008, Brownsville, 6, \$39.59	B-018-558, Buffalo Co-Op, 6, \$66.00
A-035-029, Marx Malt, 6, \$30.99			B-018-563, Labor, 2, \$38.99
A-035-039, Farmers, 6, \$26.13			B-018-568, Pechstein & Nagel, 6, \$38.50
A-035-052, Virginia, 2, \$25.99			B-018-576, Cream City, 6, \$40.00
A-035-999, Billy Huddeston Wines & Liquors Roanoke VA, 6, \$61.00			B-018-599, Hussa Bangor (BIN), 4, \$153.51
A-035-999, Herman Rosaleus Crescent City IL, 6, \$77.00			B-018-625, Berkshire, 6, \$49.66
A-035-999, Rieschel Bottlers Supply			B-018-632, Fort Schuyler, 6, \$50.00
			B-018-641, Canton, 6, \$40.00
			B-018-676, Boise, 4, \$66.01
			B-018-676, Boise, 6, \$129.49
			B-018-678, Finlay, 6, \$41.23
			B-018-999, Diehl & Lord Nashville TN, 6, \$15.59
			B-018-999, Flat Top Bottling Works

“Opener and eBay Trivia” (“BIN” Buy-It-Now & “DNMR” Did Not Meet Reserve)

Welch WV, 6, \$23.49	B-021-119, Marion, 6, \$28.79	Cola), 4, \$41.00	\$19.99
B-018-999, Pepsi=Cola Delicious and Refreshing, 6, \$87.00	B-021-124, Park, 6, \$20.50	B-021-999, Excelsior Soda Works Los Angeles, 6, \$24.76	B-031-005, Kuebler, 8, \$27.26
B-018-999, Pureoxia Ginger Ale, 4, \$9.99	B-021-129, Pilsener, 6, \$15.00	B-021-999, Indian Motorcycle New Morris Jamaica NY #434, 6, \$45.55	B-031-999, Studebaker, 6, \$22.72
B-018-CAN, Yellowhead Beer, 6, \$11.19	B-021-132, Reisch, 6, \$61.00	B-021-999, Nuebling Motorcycles Reading Pa, 8, \$15.00	B-035-001, Star Bottling Works Richmond VA, 8, \$17.05
B-018-UL, John Walter Brewing Co Eau Claire Wis, 6, \$209.71	B-021-135, Schaller Banquet, 6, \$25.00	B-022-009, Jettors, 6, \$62.99	B-035-999, The Key To Reading PA Gold Tournament 1935 (In Celluloid Case), 8, \$119.50
B-019-020, Lemp, 8, \$50.00	B-021-137, Schwarzenbach, 6, \$15.50	B-022-009, Jettors, 6, \$62.99	B-040-001, Sebewaing, 6, \$81.99
B-019-022, Maier Old Fashion, 6, \$13.01	B-021-138, Schwarzenbach, 4, \$14.10	B-022-009, Jettors, 6, \$23.68	B-040-999, NuGrape, 6, \$15.75
B-019-025, Moerlbach, 6, \$15.00	B-021-144, Auto City, 6, \$40.00	B-022-010, Jung Milwaukee, 8, \$13.49	B-042-003, Storz, 6, \$25.35
B-019-025, Moerlbach, 6, \$9.99	B-021-149, Chattanooga, 6, \$31.00	B-022-010, Jung Milwaukee, 6, \$19.00	B-042-003, Storz, 6, \$27.89
B-019-026, Neef, 6, \$17.81	B-021-149, Chattanooga, 6, \$50.99	B-022-025, Burkhardt, 6, \$15.00	B-042-999, Campanella Cigars, 6, \$23.51
B-019-037, C&J Michel Eifenbrau, 6, \$13.00	B-021-150, Consumers Penn, 4, \$21.99	B-022-029, Huebner, 8, \$22.50	B-042-999, Coca-Cola Delicious Refreshing, 6, \$51.00
B-019-040, Willow Springs, 6, \$30.00	B-021-150, Consumers Penn, 6, \$10.51	B-022-029, Huebner, 6, \$15.50	B-042-999, Coca-Cola In Bottles, 6, \$34.00
B-019-043, Buffalo Co-Op, 6, \$53.65	B-021-183, Mutual Union, 6, \$20.55	B-022-031, Michel Brown, 6, \$36.55	B-042-UL, Kiewel White Seal Beer, 6, \$52.88
B-019-051, Chautauqua, 8, \$20.50	B-021-191, Upper Penninsula, 4, \$30.00	B-022-035, Schreiber, 6, \$10.50	B-045-999, Denhalter Bottling Salt Lake City, 6, \$137.51
B-019-054, Maier / Maier, 8, \$17.29	B-021-193, Pfeiffer, 4, \$40.00	B-022-036, Hillsboro, 6, \$22.50	B-052-UL, Bartel's Beer, 6, \$26.60
B-019-057, National Leader, 8, \$19.95	B-021-197, Portland, 6, \$20.42	B-022-040, Buckeye, 6, \$20.86	B-053-004, Hauck, 6, \$95.00
B-019-058, Radake, 6, \$20.00	B-021-202, Reck, 8, \$19.50	B-022-045, Indianapolis, 4, \$30.00	B-060-001, Bartl (BIN), 6, \$250.00
B-019-058, Radke, 2, \$26.00	B-021-203, Renner & Weber, 6, \$25.00	B-022-047, Lemps, 6, \$25.75	B-060-002, Eagle (Steel), 6, \$54.00
B-019-062, Dick Bros, 8, \$15.00	B-021-205, Rose Bud, 6, \$11.29	B-022-048, C&J Michel Eifenbrau, 6, \$15.00	B-060-004, Feigenspan, 4, \$15.50
B-019-072, Badger, 4, \$20.55	B-021-228, Buffalo, 6, \$15.54	B-022-048, C&J Michel Eifenbrau, 6, \$15.00	B-063-005, Clinton, 6, \$38.77
B-019-075, Columbia, 6, \$40.99	B-021-228, Buffalo, 6, \$31.00	B-022-048, C&J Michel Eifenbrau, 6, \$15.00	B-063-015, Widman, 6, \$30.00
B-019-078, Engesser, 6, \$43.00	B-021-231, Clinton (w/ Claus Peterson Clinton Iowa Buttonhook), 6, \$27.00	B-022-053, Wilhem Schimm Ramsey, 6, \$31.01	B-064-001, Genesee, 6, \$15.50
B-019-080, Erie, 8, \$56.60	B-021-236, Crescent, 6, \$15.50	B-022-052, Tuscora, 6, \$20.50	B-065-002, Silver Foam, 4, \$22.72
B-019-082, Galion (w/ B-8-4 Home Rule B-18-520 Pilsener B-22-88 Minneapolis & 3 Misc), 6, \$32.79	B-021-236, Crescent, 6, \$32.00	B-022-053, Wilhem Schimm Ramsey, 6, \$31.01	B-065-999, Dutch Master Cigars, 6, \$27.66
B-019-101, St Joseph, 6, \$30.00	B-021-243, Excelsior, 6, \$13.00	B-022-072, P O C, 6, \$15.00	B-072-002, Old Colony, 6, \$262.55
B-019-102, Salem, 6, \$51.00	B-021-246, German, 6, \$27.55	B-022-072, P O C, 6, \$15.00	B-073-999, Pepsi-Cola (On Bottle Cap), 10, \$24.51
B-019-107, Sprenger, 6, \$12.50	B-021-247, Gettelman, 6, \$20.75	B-022-073, Reisch, 6, \$57.00	B-075-999, Stratford Ginger Ale, 4, \$18.39
B-019-115, Consumers, 6, \$30.00	B-021-252, Hagerstown, 6, \$28.00	B-022-080, Wacker, 6, \$27.66	B-999-999, (Large Oval Body w/ Badge) Zeppelin Duralumin, 6, \$61.00
B-019-153, Leisy, 6, \$16.50	B-021-259, Cream City, 6, \$16.05	B-022-088, Minneapolis, 4, \$15.55	B-999-999, B-18/21 w/ Abalone Handles w/ Compass, 6, \$48.88
B-019-155, Willow Springs, 6, \$20.50	B-021-275, List-Erl-King, 6, \$25.09	B-022-088, Minneapolis, 4, \$15.55	C-001-003, Schoenhofen, 8, \$57.55
B-019-156, Eulberg, 6, \$30.00	B-021-276, Los Angeles, 6, \$38.00	B-022-088, Minneapolis (w/ B-8-4 Home Rule B-18-520 Pilsener B-19-82 Galion & 3 Misc), 6, \$32.79	C-001-003, Schoenhofen Edelweiss (BIN), 6, \$15.00
B-019-166, Hammes, 6, \$29.31	B-021-295, Park, 6, \$72.56	B-022-089, Jetter, 6, \$20.49	C-001-004, Scheidt, 8, \$43.80
B-019-170, Minneapolis Var B, 6, \$15.51	B-021-303, Schaller Eclipse, 4, \$30.00	B-022-091, Stevens Point, 6, \$82.88	C-002-001, Phoenix, 8, \$26.00
B-019-173, Farmers, 6, \$27.09	B-021-304, Schreiber, 6, \$21.09	B-022-999, Coca-Cola / Texas M&M Co, 6, \$81.99	C-002-001, Phoenix, 6, \$33.00
B-019-178, Montana (w/ P-19-2 Townsend), 8, \$46.00	B-021-327, Hubach, 6, \$30.00	B-022-999, The Atlantic Bar Butte MT, 8, \$26.69	C-002-003, Hutchinson, 8, \$40.00
B-019-189, Fuhmann, 6, \$36.00	B-021-339, Dubuque, 6, \$21.50	B-023-018, Miller, 8, \$19.99	C-002-004, Independent, 6, \$56.00
B-019-195, Walla Walla, 6, \$33.00	B-021-358, Schlitz, 8, \$25.00	B-023-028, Schreiber, 6, \$43.00	C-002-005, Pittsburgh, 4, \$86.00
B-019-205, Lion, 6, \$25.00	B-021-367, Diamond Spring, 6, \$45.88	B-023-033, Golden Glow, 6, \$14.88	C-002-005, Pittsburgh (BIN), 8, \$40.00
B-019-205, Lion, 6, \$9.95	B-021-367, Diamond Spring, 8, \$46.88	B-023-036, Ebner, 6, \$27.03	C-003-005, Fremont, 4, \$14.06
B-019-221, Muessel, 4, \$10.49	B-021-368, Elgin, 6, \$16.01	B-023-049, Walters, 6, \$49.00	C-005-013, Henning, 6, \$60.00
B-019-229, Broadway, 6, \$86.00	B-021-372, Fremont, 6, \$12.62	B-023-058, South Fork, 6, \$15.00	C-005-013, Henning, 6, \$61.00
B-019-231, Plymouth, 6, \$30.00	B-021-374, Gilbert, 4, \$62.65	B-023-069, Hammes, 6, \$13.10	C-008-003, Hammes, 6, \$15.99
B-019-243, Independent, 6, \$104.05	B-021-375, Glencoe, 6, \$52.11	B-023-073, C&J Michel, 6, \$9.99	C-010-012, Koerber (3 Examples), 6, \$22.06
B-019-245, Ulmer, 4, \$31.05	B-021-381, Metz, 6, \$51.00	B-023-076, Overland, 6, \$15.00	C-010-021, Stein, 8, \$31.25
B-019-249, Finke-Uhen, 6, \$24.99	B-021-381, Omaha, 6, \$20.50	B-023-080, Sehring, 6, \$36.51	C-011-020, Kamm & Schellinger, 6, \$26.09
B-019-262, Ashland, 6, \$47.88	B-021-392, Beckweiser, 2, \$20.51	B-023-083, American, 6, \$18.01	C-012-013, Hawaii, 8, \$9.99
B-019-265, Marion, 6, \$58.09	B-021-394, Colfax, 6, \$40.00	B-023-145, White Rose, 6, \$9.99	C-012-092, Peerless, 8, \$13.50
B-019-UL, John Hauck Brewing Cincinnati, 6, \$102.50	B-021-400, Lansing, 6, \$78.77	B-023-164, Butte Bottles, 6, \$17.15	C-012-125, Knapstein, 8, \$19.99
B-019-UL, Wieczorek Horlacher Allentown PA, 6, \$12.51	B-021-405, Potosi, 4, \$62.52	B-023-164, Butte Bottles, 6, \$17.15	C-012-142, Binzel, 6, \$68.89
B-021-024, Grand Rapids, 6, \$30.00	B-021-412, Consumers, 6, \$9.99	B-023-UL, Pabst Blue Ribbon Malt Oakland CA, 6, \$52.00	C-012-999, National Baseball Hall of Fame (On Badge), 6, \$37.51
B-021-029, Hopsburger (MIP), 10, \$22.50	B-021-418, Jettors, 6, \$41.00	B-024-014, Gipps, 6, \$52.99	C-013-058, Highland, 8, \$11.01
B-021-035, Hyde Park, 6, \$26.81	B-021-430, Old Colony, 6, \$32.05	B-024-039, Walters, 6, \$13.01	C-013-120, Ziegler (BIN), 4, \$25.00
B-021-052, Moerlein, 6, \$30.75	B-021-436, Virginia, 6, \$27.00	B-024-037, Acme Los Angeles, 6, \$13.50	C-013-129, Elk, 6, \$29.00
B-021-055, Mutual, 6, \$17.00	B-021-445, Helb, 6, \$51.00	B-024-076, Blue N Gold, 8, \$18.55	C-013-139, Hoerber, 8, \$32.11
B-021-060, Neefs, 6, \$14.00	B-021-447, Port Huron, 6, \$40.00	B-024-076, Blue N Gold, 8, \$18.55	C-013-139, Hoerber, 8, \$15.93
B-021-076, Schlitz, 8, \$31.00	B-021-454, Dotterweich, 6, \$57.55	B-024-088, Semrad-Pusch, 6, \$56.00	C-013-139, Hoerber, 8, \$20.50
B-021-086, Tivoli, 6, \$26.00	B-021-454, Dotterweich, 6, \$61.00	B-024-102, Yuengling, 8, \$21.91	C-013-187, Pointer, 6, \$17.50
B-021-089, Walters, 4, \$39.00	B-021-481, Fink Malt, 6, \$9.99	B-024-102, Yuengling, 4, \$15.50	C-013-194, Star Wooden Shoe, 6, \$18.52
B-021-090, White Eagle, 6, \$30.00	B-021-487, Hyde Park, 6, \$26.81	B-024-109, Moore & Quinn, 6, \$19.39	C-013-211, Crockery City (w/ 3 Misc), 6, \$7.10
B-021-094, Amsterdam, 6, \$15.00	B-021-493, Owyhee (w/ Picnic Paper Package), 6, \$131.50	B-024-999, Coca-Cola In Bottles, 6, \$15.78	
B-021-107, Hagemeister, 6, \$67.00	B-021-519, Golden West, 6, \$33.00	B-024-999, Coca-Cola In Bottles (2 Examples), 6, \$45.44	
B-021-111, Houston, 4, \$33.02	B-021-525, Yonkers, 4, \$15.00	B-027-001, Miller Var A, 6, \$24.99	
B-021-113, Jung, 4, \$76.00	B-021-532, West End, 6, \$40.00	B-027-001, Miller Var A, 6, \$31.55	
B-021-116, Klausmann, 6, \$20.50	B-021-538, Fox Lake, 6, \$41.99	B-029-999, Williamson Prest-O-lite (w/ Tag), 6, \$26.00	
B-021-116, Klausmann, 6, \$17.49	B-021-541, New Bethlehem, 6, \$20.52	B-030-999, Coca-Cola Bottling Works Bethlehem PA, 10, \$61.00	
	B-021-565, Burkhardt, 6, \$30.00	B-030-999, Pepsi-Cola Charles Wieand Phone 4878, 6, \$50.00	
	B-021-580, Sheridan, 6, \$78.70	B-030-999, Whistle Lebanon PA, 6, \$50.00	
	B-021-592, West Bend, 6, \$40.00		
	B-021-999, Chippewa Falls Spring Water, 6, \$26.00		
	B-021-999, Coca-Cola (w/ B-19 Coca-		

“Opener and eBay Trivia” (“BIN” Buy-It-Now & “DNMR” Did Not Meet Reserve)

C-013-255, Mexicali Malt, 6, \$34.60	\$86.00	D-999-ENG, Cat's Paw, 6, \$73.34	E-006-065, Bridgeport, 6, \$29.09
C-013-260, Dutch Maid, 6, \$15.91	CBO-PKT-06, Banker Cigars, 6, \$29.99	D-999-ENG, Cat's Paw, 6, \$28.77	E-006-065, Bridgeport, 6, \$12.10
C-013-276, Windber Corp, 6, \$39.88	CBO-PKT-07, San Felice 5c Cigar	E-001-023, Hensler, 6, \$22.49	E-006-077, Diehl, 6, \$10.75
C-013-277, Birk Bros, 6, \$14.38	Deisel-Wemmer Co Lima OH, 4,	E-001-029, Belmont Pink Elephant, 4,	E-006-077, Watertown, 6, \$43.35
C-017-006, Goetz, 6, \$11.50	\$24.95	\$28.00	E-006-100, Elder Brau, 4, \$26.01
C-017-065, Victor, 6, \$21.49	CBO-RBO-06, Memphis Bridge Ci-	E-001-030, Hemrich, 6, \$18.00	E-006-119, Old King Cole Beer (w/ E-6
C-018-999, Vernor's Ginger Ale 80th	gars, 6, \$21.95	E-001-034, Monarch, 6, \$21.10	-186), 6, \$16.00
Anniv, 6, \$12.50	CBO-RND-03, Chase's Hand Made	E-001-038, Boyertown, 6, \$44.53	E-006-125, Vernon, 6, \$9.99
C-019-999, Kist (Red), 8, \$14.65	Cigars, 6, \$21.02	E-001-999, Pepsi Cola Lynchburg, 6,	E-006-140, Jenner Springs, 6, \$11.50
C-020-001, Betz, 6, \$15.00	CBO-RND-09, Santa Fe Cigars, 6,	\$33.03	E-006-170, Al's, 6, \$15.00
C-020-010, Peter, 8, \$8.99	\$37.98	E-001-999, Pepsi-Cola A Nickel Drink,	E-006-186, Old King Cole Beer (w/ E-6
C-022-002, Ruppert, 6, \$16.38	CBO-RND-13, Flor De Morales, 6,	6, \$23.00	-119), 6, \$16.00
CBO-BB-10, Defiance Cigars (w/	\$46.02	E-002-051, Hop Gold, 6, \$13.38	E-006-191, Sunset, 6, \$15.00
Case), 6, \$18.48	CBO-SEP-01, La Mona Cigars New	E-003-003, DelMarVa, 6, \$28.00	E-006-202, Old King Cole, 6, \$9.99
CBO-BB-07, Joe Pelican Cigar, 6,	York, 6, \$22.50	E-003-025, Wacker, 6, \$31.01	E-006-228, Wachter, 6, \$19.49
\$19.38	CBO-SEP-02, Henry Berger Cigars, 6,	E-003-053, Leinenkugel, 6, \$68.89	E-006-999, Gordon Bottling Works
CBO-BB-10, Captivator Cigars, 6,	\$19.00	E-003-053, Leinenkugel, 6, \$68.89	Cobleskill NY, 6, \$16.10
\$20.00	CBO-SEP-03, Esberg-Gunst Portland	E-003-053, Leinenkugel, 6, \$19.50	E-006-999, Nehi Poughkeepsie, 6,
CBO-BB-10, Noyes Bros St Paul MN,	OR, 6, \$45.51	E-003-056, Abner-Drury, 6, \$22.49	\$16.50
6, \$16.46	CBO-SEP-05, C S Osborne Newark	E-003-057, Auto City, 8, \$41.00	E-007-001, Atlas, 6, \$11.00
CBO-BB-11, El Yutan, 2, \$21.03	NJ, 6, \$22.22	E-003-063, Bohemian Club, 6, \$17.00	E-007-002, Burkhardt, 6, \$38.25
CBO-BB-12A, Sincerity Cigars Chas F	CBO-SHM-01, Red Dot 5c Cigars, 6,	E-003-063, Bohemian Club, 6, \$19.99	E-007-018, Krueger, 6, \$9.99
Pusch Marysville KS (No Hole),	\$37.55	E-003-999, Nehi Providence RI, 6,	E-007-037, Renner, 6, \$15.00
6, \$24.47	CBO-SHM-02, Blank, 8, \$52.51	\$23.97	E-007-045, Virginia, 6, \$25.49
CBO-BB-19, Miller, Debrul & Peters	CBO-SHM-02, Emanelo Cigars, 6,	E-004-023, Cold Spring, 6, \$12.99	E-007-UL, Niagara Falls Brewing
Mfg, 8, \$67.98	\$38.88	E-004-043, Heurich, 6, \$78.00	Spray Beer, 6, \$205.00
CBO-BB-ND, Kahnello Havana Cigars	CBO-SHM-03, Muriel Cigar Joplin	E-004-044, Hollenkamp, 6, \$36.77	E-008-017, Fink Var A, 6, \$15.73
Fleck Cigar Co, 6, \$58.00	Tobacco Co, 6, \$17.19	E-004-045, Hornung, 6, \$15.00	E-008-028, Ruhstallers, 6, \$23.51
CBO-BUT-03, Hazinski & Sons South	CBO-SHM-03, R B 5c Cigars, 6, \$14.17	E-004-060, Miami Valley, 6, \$36.77	E-008-999, Drink Hires In Bottles, 6,
Bend IN, 6, \$28.00	CBO-SHM-04, George W Walker Ci-	E-004-064, Neustadt, 6, \$15.00	\$11.59
CBO-DHM-02, Select Cigars, 8, \$20.55	gars Los Angeles CA, 6, \$23.00	E-004-082, Schneider, 6, \$15.00	E-009-019, Ruppert, 6, \$0.99
CBO-DHM-07-A, Wiedemann Cigar	CBO-SHM-04, Legation 5c Cigars, 6,	E-004-086, Pilsener, 6, \$30.86	E-009-039, National, 6, \$19.09
Box Co St Louis, 6, \$42.01	\$15.47	E-004-106, Chester, 6, \$10.55	E-009-040, Paducah, 6, \$58.00
CBO-DHM-10, Smoke Signers Smoke	CBO-SHM-07, Grinnel Club & Dia-	E-004-112, Electric City, 6, \$41.00	E-009-043, Ruhstaller, 6, \$15.00
Union Maid, 6, \$11.50	mond Eye Cigars, 6, \$25.00	E-004-145, Senate, 6, \$88.88	E-009-054, Hanley, 6, \$20.50
CBO-DHM-10, Wurtz Cigars, 6, \$32.97	CBO-SHM-07, Smoke Equity Cigars,	E-004-145, Senate, 6, \$117.50	E-009-075, Monumental, 6, \$25.00
CBO-DHM-10, Yale 5c Cigar, 6, \$26.25	6, \$37.99	E-004-153, Washington, 6, \$16.50	E-009-076, National, 6, \$11.50
CBO-DHM-12, Smoke La Venero Ci-	CBO-SHM-10, Compliments of Adam,	E-004-180, Milwaukee, 6, \$15.00	E-009-090, Everard, 6, \$25.00
gars, 8, \$27.00	6, \$22.72	E-004-181, Northern, 6, \$68.89	E-009-999, Alamosa Bottling Works,
CBO-DHM-19, Prince Tallyrand Cigar	CBO-SHM-12, Blackwell's Durham	E-004-182, Old Joe, 6, \$23.50	6, \$8.61
(No Hole), 4, \$29.99	Cigar, 6, \$62.98	E-004-183, Old King, 6, \$25.00	E-009-999, Coca-Cola Beatrice NE (w/
CBO-HBO-04, Monogram Cigars, 6,	CBO-SQR-04, Stickney Cigar St Louis	E-004-206, Weinhard, 6, \$15.00	5 Misc), 6, \$37.75
\$13.53	MO, 6, \$48.00	E-004-263, Walter, 6, \$36.88	E-009-999, Drink Berrju, 4, \$15.50
CBO-HBO-11, 1915 Patent (No Ad), 8,	D-001-001, Budweiser Var A, 6, \$10.00	E-004-276, Blitz-Weinhard, 6, \$15.00	E-009-999, Pepsi-Cola, 6, \$36.01
\$15.53	D-001-001, Budweiser Var B, 6, \$8.02	E-004-279, Jackson, 6, \$25.00	E-009-999, Star Botting & Supply
CBO-HKH-02, Canto & Judge Cigars	D-001-001, Budweiser Var B, 6, \$31.50	E-004-302, Hollenkamp, 6, \$51.77	New Haven CT, 6, \$10.50
Detroit, 6, \$22.55	D-001-014, Fauerbach, 6, \$10.52	E-004-336, Oertels, 6, \$16.28	E-009-UL, Carson City Brewing Tahoe
CBO-HKH-02, Rose-O-Cuba Cigars, 6,	D-001-014, Fauerbach, 6, \$11.50	E-004-999, (w/ Screwdriver Tip) Wil-	Beer, 6, \$202.19
\$16.50	D-001-014, Fauerbach, 8, \$26.00	liam H Nobman The Winchester	E-011-011, American, 6, \$21.55
CBO-HKH-02A, Joe E Canto & Judge	D-001-016, Maier, 2, \$9.99	Store / Oyster Bay NY, 6,	E-011-016, Dixie, 6, \$15.00
Phelan Cigar, 6, \$23.49	D-001-019, \$1,000, 6, \$39.99	\$189.99	E-013-032, Yoergs (2 Examples), 6,
CBO-HKH-04, Idora 5c Cigars, 6,	D-001-029, Burkhardts, 6, \$50.00	E-004-999, Coca-Cola / Same (w/ 2	\$21.01
\$19.46	D-001-032, Lange, 6, \$107.50	Misc), 6, \$77.28	E-014-314, Apache, 6, \$11.01
CBO-HKH-04, Moeller & Kolb Mfgr of	D-001-035, C&J Michel, 6, \$100.00	E-004-999, Drink Moxie, 6, \$10.99	E-014-314, Apache, 6, \$26.59
Cigar Boxes Chicago, 6, \$17.03	D-001-039, Strohs, 6, \$50.00	E-004-999, Pepsi-Cola, 6, \$18.64	E-014-329, Boyertown, 6, \$53.00
CBO-HKH-05, 7-20-4 Cigars, 8, \$17.55	D-003-005, Terre Haute, 6, \$39.32	E-004-UL, Kent Brewing West War-	E-014-365, Gallatin, 6, \$9.95
CBO-HKH-05, El Bello Cigars, 6,	D-003-010, Berghoff, 6, \$28.41	wick RI (BIN), 6, \$20.00	E-014-379, Heurich, 6, \$56.00
\$24.99	D-003-020, Miller, 6, \$111.00	E-005-999, 7Up Minars Seven-Up Co	E-014-379, Heurich Senate, 6, \$10.50
CBO-HKH-06, Coleman Cigar Co	D-003-020, Miller, 4, \$31.40	Fergus Falls MN, 8, \$14.50	E-014-386, Imperial, 6, \$11.05
Superior WI, 6, \$15.48	D-003-021, Reisch, 6, \$80.00	E-005-999, Coca-Cola Bottling Co Tell	E-014-404, Marathon City, 6, \$12.97
CBO-HKH-06, Little Egypt 5c Cigar, 6,	D-003-ENG, Coca-Cola, 6, \$71.62	Cuty IN, 8, \$149.49	E-014-442, Southern, 6, \$24.37
\$20.50	D-003-ENG, Derby / Burrows & Stur-	E-005-999, Pepsi=Cola (Bottle) Cleve-	E-014-484, Crete, 4, \$6.00
CBO-HOR-05, Colon Mild Havana	gess, 6, \$36.85	land OH, 8, \$47.00	E-014-486, Dallas-Ft Worth, 6, \$15.00
Cigars, 8, \$116.49	D-003-ENG, Pepsi-Cola (Short Han-	E-005-999, Pepsi=Cola (Bottle)	E-014-494, Fallstaff, 8, \$25.00
CBO-HOR-05, Snyder & Brewer Ci-	dle), 6, \$21.71	Cloumbus MS, 6, \$46.99	E-014-521, Magnolia, 2, \$10.00
gars Hastings NE, 6, \$67.69	D-009-017, Salem, 8, \$50.00	E-005-999, Pepsi=Cola (Bottle) Wau-	E-014-592, Chautauqua, 6, \$24.49
CBO-HT-01A, Flor de Murat Cigars, 6,	D-009-018, Hardings, 6, \$41.00	sau Beverage, 6, \$41.00	E-014-600, Bechaud, 6, \$29.99
\$42.98	D-011-001, Hagerstown, 4, \$45.99	E-005-999, Pepsi=Cola (In Bottle Cap)	E-014-600, Bechaud, 6, \$36.01
CBO-HT-02, Bab's Best, 2, \$18.47	D-011-001, Hagerstown, 6, \$59.00	R M Hicks Dist, 6, \$57.74	E-014-602, Fergus, 6, \$15.59
CBO-HT-07, Kingbiel Cigars, 6, \$40.00	D-012-004, Ruppert, 6, \$30.92	E-005-999, Pepsi=Cola Albrecht Bev-	E-014-655, Roger Williams, 6, \$26.00
CBO-MIS-10, El Verso San Felice	D-012-004, Ruppert, 6, \$14.99	erages, 6, \$45.00	E-014-665, Renner, 6, \$6.65
Cigars, 4, \$15.51	D-012-007, Mass, 6, \$36.88	E-005-999, Pepsi=Cola Cloverdale	E-014-690, Glacier, 6, \$20.00
CBO-MIS-13, George Washington, 6,	D-012-013, Excelsior, 6, \$40.00	Walter Bros Chambersburg PA,	E-014-723, Kim, 6, \$9.99
\$32.99	D-022-UL, Voights Nurishin Malt	8, \$67.00	E-014-819, Sabinas, 6, \$20.00
CBO-NL-03, M & O Havana Cuban	(BIN), 4, \$30.00	E-005-999, Pepsi=Cola Petersburg	E-014-833, Wacker, 6, \$9.99
Cigars Denver, 6, \$18.47	D-999-AUS, Castle Beer (Castle	WV, 6, \$33.50	E-014-849, Wachter, 6, \$31.00
CBO-NL-03, Schneiders Wm Barclay	Shaped), 6, \$40.00	E-005-999, Pepsi-Cola Hutchinson	E-016-007, Fink, 6, \$14.56
Cigars 5c, 6, \$14.99	D-999-AUS, Lion Stout, 6, \$52.94	KS, 6, \$33.00	E-019-001, American, 6, \$50.00
CBO-PKT-04, Carl Wilhelm Bremen, 8,	D-999-ENG, Cat's Paw, 6, \$40.99	E-006-061, Bechaud, 6, \$25.00	E-019-003, Fitgers, 4, \$15.59

"Opener and eBay Trivia" ("BIN" Buy-It-Now & "DNMR" Did Not Meet Reserve)

E-024-999, Pepsi=Cola, 7, \$76.99	"I"s), 6, \$9.99	K-002-006, Pearl, 8, \$64.00	M-003-014, Piels (Green), 8, \$39.99
E-025-009, Daeufer, 6, \$39.88	G-004-018, Soiuthern, 6, \$64.77	K-004-001, Pabst Var A (DNMR), 6, \$61.00	M-003-014, Piels (Red), 8, \$17.51
E-028-999, Harley-Davidson Motorcycles Allentown Motorcycle Co, 4, \$53.88	G-005-006, Lion Export, 6, \$33.00	K-005-004, Miller, 8, \$27.91	M-003-017, Schorr-Kolkschneider, 6, \$26.00
E-030-999, Original Mine Butte MT, 6, \$33.51	G-005-008, Wetterer, 6, \$33.00	K-005-004, Miller (Brown Spotted on White), 8, \$33.88	M-003-017, Schorr-Kolkschneider, 6, \$19.99
F-001-001, Langs, 8, \$26.57	G-005-009, Hagemeister, 4, \$62.00	K-006-999, Blank (No Ad) (BIN), 6, \$24.99	M-003-019, Zetts (BIN), 8, \$39.00
F-002-011, Wacker, 6, \$22.01	G-005-013, Gunds, 6, \$36.79	L-001-001, Blatz, 6, \$21.50	M-003-019, Zetts (BIN), 8, \$55.00
F-002-023, Gluek, 6, \$12.00	G-005-039, Bartholomay, 6, \$37.54	L-001-001, Blatz, 8, \$20.00	M-003-032, Lang, 4, \$34.00
F-002-999, Hotel Swastika Raton NM, 6, \$45.00	G-006-999, Coca-Cola In Bottles, 6, \$14.00	L-001-001, Blatz, 8, \$16.05	M-003-032, Lang, 8, \$40.00
F-002-999, Moxie / Pureoxia, 6, \$29.99	G-009-050, Hamms, 6, \$19.99	L-001-002, Budweiser, 8, \$22.52	M-003-036, Piel Bros, 6, \$67.89
F-002-999, Pepsi-Cola, 6, \$32.02	G-009-074, Kessler, 6, \$22.49	L-001-003, Coors, 8, \$54.00	M-003-046, Schneider, 8, \$65.88
F-003-999, Sunset Beer Distributors Upper Darby PA, 6, \$19.99	G-009-107, Potosi, 8, \$37.01	L-001-006, Ruppert, 8, \$19.38	M-003-999, 1933 Chicago WFs, 8, \$48.99
F-004-002, Iroquois, 6, \$24.01	G-009-107, Potosi, 4, \$37.88	L-001-006, Ruppert w/ 1 Misc (BIN), 8, \$25.00	M-003-999, 1934 Chicago WFs, 6, \$24.50
F-004-020, Schlitz, 6, \$16.00	G-009-CAN, Pepsi-Cola (Canadian Made G-9), 8, \$23.50	L-001-007, Schlitz, 8, \$15.50	M-003-999, 1934 Chicago WFs, 8, \$32.69
F-004-999, Coca-Cola Pure Drink, 2, \$56.55	G-010-999, Ideal Combination It-Pulls-Them-All No. 3, 6, \$69.99	L-001-999, Carlsberg Pilsner, 8, \$138.53	M-003-999, 1934 Chicago WFs, 6, \$53.00
F-004-999, Orange Crush Pop-Kola WR Stumpff Sulphur OK, 6, \$56.55	G-019-002, Genesee, 4, \$51.00	L-001-999, Island Inn Daiquiri Mix Punch, 8, \$42.88	M-003-999, 1939 New York World's Fair (BIN), 6, \$99.95
F-005-038, Flint Malt, 6, \$15.00	G-021-999, Phillips Bros, 6, \$12.62	L-002-001, Anheuser-Busch Var A, 6, \$38.99	M-003-999, Allegheny Metal (Red), 8, \$29.26
F-005-999, Coca-Cola In Bottles, 4, \$68.42	G-025-999, Tip Top Soda, 6, \$19.95	L-002-001, Anheuser-Busch Var A, 6, \$20.00	M-003-999, Dr Pepper, 8, \$41.00
F-005-999, Coca-Cola In Bottles, 4, \$36.00	G-040-001, Berghoff, 6, \$80.00	L-002-001, Anheuser-Busch Var A, 8, \$51.00	M-003-999, Dr Pepper, 8, \$56.00
F-005-999, Coca-Cola In Bottles / Batchelor Ginger Ale, 4, \$62.07	G-053-002, Ye Tavern, 6, \$67.60	L-002-001, Anheuser-Busch Var A, 6, \$36.00	M-003-999, Dr Pepper, 8, \$46.00
F-005-999, Coca-Cola Milwaukee Grand 1906, 6, \$77.01	H-001-011, Sprenger, 8, \$26.25	L-002-001, Anheuser-Busch Var B, 6, \$67.01	M-003-999, Hunter Island Inn, 8, \$78.59
F-005-999, Girard Spring Water Pawtucket RI, 6, \$23.50	H-001-025, Phoenix, 8, \$20.51	L-002-002, A-B Malt Nutrine, 6, \$26.00	M-003-999, Moxie, 8, \$20.49
F-006-007, Huebner, 6, \$40.00	H-001-044, Norton Gold Band, 6, \$26.60	L-002-002, A-B Malt Nutrine, 6, \$31.00	M-003-999, Moxie (w/ F-5 Moxie & E-8 Moxie), 6, \$65.01
F-006-025, Doelger, 6, \$25.00	H-001-045, Tivoli, 6, \$23.10	L-002-002, A-B Malt Nutrine (w/ L-2-1 A-B Var A), 6, \$76.79	M-003-999, Sardi's Restaurant, 2, \$17.49
F-006-081, Muessel, 6, \$39.09	H-002-022, Hanley, 8, \$24.99	L-002-004, Buffalo Co-Op, 6, \$116.49	M-003-999, Sardi's Restaurant, 8, \$37.88
F-006-999, Coca-Cola Bottling Works Waynesboro PA, 6, \$133.98	H-002-034, Rahr, 8, \$14.99	L-002-005, Eldredge, 6, \$50.00	M-006-001, Gibbons, 8, \$12.00
F-006-UL, Wagner's Augustiner, 4, \$43.99	H-002-046, Wacker, 2, \$30.09	L-002-005, Eldredge, 6, \$81.88	M-006-001, Gibbons, 8, \$34.91
F-009-003, Fortune Bros (No Opener), 6, \$39.99	H-002-068, Leinenkugel, 8, \$11.61	L-002-012, Windisch-Muhlhauser, 6, \$121.49	M-006-004, Pennsy, 6, \$25.00
F-009-UL, Products Superiores / Malt Vigor / Milwaukee Brew / Bavarian Brew, 6, \$78.99	H-002-073, Steinerbru, 8, \$77.77	L-002-019, Terre Haute, 6, \$124.50	M-006-006, Wagner, 6, \$17.67
F-011-001, Cleveland & Sandusky, 6, \$16.66	H-002-073, Steinerbru, 8, \$78.77	L-002-999, 1893 Columbian Expo (Case Cracked), 2, \$57.21	M-006-006, Wagner, 6, \$49.99
F-013-002, Becker Products, 6, \$39.99	H-002-077, Abner-Drury, 6, \$56.00	L-002-999, Devil (Pic of Devil) Has A Screw, 6, \$143.50	M-006-011, Signal, 4, \$16.58
F-015-UL, Utica Club Beer, 8, \$30.99	H-002-152, Dicks, 6, \$25.00	L-004-009, Fehrs, 8, \$26.00	M-006-999, Detroit Yacht Club 1938, 6, \$36.35
F-027-999, Coca-Cola Baltimore MD, 6, \$95.65	H-002-157, Burkhardt, 6, \$19.10	L-004-011, Flecks, 8, \$35.57	M-007-001, Duquesne, 6, \$14.55
F-027-999, Coca-Cola In Bottles Baltimore MD (BIN), 6, \$90.00	H-002-218, Wentzler, 6, \$26.00	L-004-012, Gluek, 8, \$56.79	M-007-001, Duquesne, 6, \$14.99
F-032-003, Gunther, 4, \$40.99	H-002-999, Bethesda Mineral Spring Company Waukesha WI, 4, \$32.00	L-004-026, Red Top, 8, \$36.01	M-007-001, Duquesne, 6, \$41.00
F-032-004, Hamm, 4, \$30.00	H-003-003, Dicks, 6, \$18.05	L-004-062, Blatz, 8, \$31.00	M-019-002, Miller, 8, \$33.10
F-999-999, (F-12 with Ladle End) Geo C & Robt M "Woods Goods", 6, \$25.00	H-004-001, Prima, 8, \$13.00	L-004-UL?, Jax Beer Jackson Brewing New Orleans LA (Foil Label), 8, \$47.99	M-019-002, Miller, 8, \$63.44
FBOC-024, Mexican Cactus (BIN), 8, \$175.00	H-007-006, Knapp, 6, \$49.99	L-005-001, Primo, 6, \$17.50	M-019-002, Miller, 6, \$42.00
FBOC-043, Grass Skirt Greek (On Ashtray), 6, \$103.49	H-007-009, Potosi, 8, \$16.29	L-999-999, (Similar L-1 But Bottle Shaped) Bank Beer (Fantasy ???), 8, \$76.00	M-019-002, Miller, 8, \$69.51
FBOC-044, Black Caddy, 8, \$125.00	H-008-007, Griesedieck Bros, 8, \$55.01	L-999-999, (Similar L-1 But Bottle Shaped) Bosch Brewing Co Bock Edge Beer (Fantasy), 8, \$18.85	M-019-002, Miller, 6, \$44.10
FBOC-129, Pelican, 8, \$55.00	H-008-008, Iroquois, 8, \$42.09	L-999-999, (Similar L-1 But Bottle Shaped) Heileman Old Style (Fantasy), 8, \$17.50	M-019-002, Miller (Best Offer), 8, \$60.00
FBOC-145, Dragon, 6, \$62.50	H-008-008, Iroquois, 8, \$37.55	M-001-999, Major Cola, 4, \$25.00	M-019-002, Miller (BIN), 8, \$40.00
FBOC-422, Amish Man, 6, \$500.00	H-008-016, Narragansett, 8, \$36.00	M-002-004, Harvard, 6, \$67.00	M-019-003, Narragansett, 6, \$77.00
FBOC-533, Mr Peanut, 8, \$112.49	H-008-016, Narragansett Banquet, 8, \$19.99	M-002-005, Bartholomay, 4, \$34.33	M-019-003, Narragansett, 6, \$82.88
G-001-028, Alpen Brau, 8, \$32.75	H-008-019, Atlantic, 8, \$41.00	M-002-012, Berry, 6, \$152.50	M-019-003, Narragansett, 6, \$76.51
G-001-036, Marathon City, 6, \$13.63	H-008-999, Pepsi=Cola, 8, \$19.99	M-002-013, Canandaigua, 6, \$51.00	M-019-005, Budweiser (MIB), 10, \$11.50
G-001-046, Berghoff, 4, \$22.50	H-010-002, Star, 6, \$38.88	M-002-999, Pureoxia, 6, \$26.00	M-019-006, Froedtert Malt, 6, \$43.51
G-001-051, Lubeck, 6, \$57.78	H-010-002, Star Wooden Shoe, 8, \$56.55	M-003-004, Daeufer, 8, \$12.52	M-019-022, Schlitz, 8, \$11.47
G-001-069, Leideger 3-V Beverages, 6, \$69.99	H-010-999, Henry Newman's Thirst Parlor Seward Neb, 6, \$31.01	M-003-005, Edelweiss, 6, \$32.01	M-019-022, Schlitz (MIB), 10, \$30.00
G-001-999, Drink Coca-Cola, 6, \$32.85	H-010-002, Star, 6, \$38.88	M-003-005, Edelweiss (Black), 6, \$40.95	M-019-027, Coors (BIN), 10, \$27.00
G-001-999, Pepsi=Cola 5c, 6, \$12.50	H-010-002, Star, 6, \$38.88	M-003-005, Edelweiss (Yellow), 8, \$30.88	M-019-999, Anaconda, 6, \$64.88
G-003-004, Walters, 6, \$22.00	I-007-078, Malt-Diastase (Piercer Filed Down) (BIN), 4, \$30.00	M-003-007, Gunther, 8, \$31.96	M-019-999, Coca-Cola (Repro), 8, \$75.00
G-003-008, Schneider, 6, \$15.00	I-009-004, Waldorf Beer, 6, \$9.99	M-003-011, Cumberland, 8, \$42.50	M-019-999, Coca-Cola (Repro), 6, \$75.00
G-003-010, Zollers, 6, \$24.00	I-012-038, Hamms (Box of 500), 10, \$330.00	M-003-012, German, 6, \$39.09	
G-003-013, Hauenstein (w/ 5 Misc	I-012-178, Hamms (Case of 500), 10, \$169.10		

“Opener and eBay Trivia” (“BIN” Buy-It-Now & “DNMR” Did Not Meet Reserve)

\$76.51	M-073-014, Budweiser Becker, 8, \$188.20	N-027-004, Budweiser Var A, 6, \$10.45	O-002-019, Marathon, 8, \$36.35
M-019-999, Coca-Cola (Repro), 8, \$130.49	M-073-999, 1934 Chicago WFs, 2, \$47.58	N-027-004, Budweiser Var A, 8, \$13.06	O-002-025, National, 6, \$22.60
M-019-999, Coca-Cola (Repro), 8, \$88.77	M-073-999, 1934 Chicago WFs, 4, \$54.01	N-027-021, Hamm's, 8, \$89.00	O-002-026, Genesee, 8, \$67.66
M-019-999, Dr Pepper (Fantasy), 8, \$69.98	M-073-999, Electro-Chemical (Red), 6, \$255.69	N-027-UL, Holiday and Gartenbrau Beer, 6, \$9.99	O-002-026, Genesee, 8, \$124.72
M-019-999, Orange Crush (Fantasy), 8, \$45.44	M-073-999, Hotel Gowman (Red), 7, \$118.51	N-029-003, Homestead (No Pencil), 2, \$34.00	O-002-027, Griesedieck Bros, 8, \$26.75
M-019-999, Pepsi=Cola, 6, \$29.99	M-076-001, Schlitz, 8, \$9.99	N-029-999, Dr Pepper, 8, \$78.77	O-002-027, Griesedieck Bros, 8, \$20.75
M-019-999, Pepsi=Cola, 6, \$33.00	M-089-UL, Budweiser Southern Beverage Herrin, ILL., 6, \$63.00	N-029-999, Dr Pepper, 6, \$39.99	O-002-999, 7Up, 8, \$48.56
M-019-999, Pepsi=Cola, 6, \$35.33	M-098-001, Pabst-Leinenkugel, 8, \$19.99	N-029-999, Dr Pepper, 8, \$62.99	O-002-999, 7Up, 8, \$58.57
M-019-999, Pepsi=Cola, 6, \$36.10	M-140-999, 1933-34 Chicago WFs, 4, \$99.00	N-029-999, Dr Pepper, 6, \$37.76	O-002-999, Blue Ribbon Feeds and Poultry, 8, \$52.76
M-019-999, Pepsi=Cola, 6, \$36.35	M-154-001, Bridgeport (MIB), 10, \$240.75	N-029-999, Drink Coca-Cola In Bottles Pure As Sunlight, 8, \$256.07	O-002-999, Cloverdale Soft Drinks (Pic of Clover), 6, \$62.01
M-019-999, Pepsi=Cola, 6, \$48.69	M-160-001, Miller, 10, \$21.47	N-029-999, Royal Crown Bottling Co, 6, \$14.50	O-002-999, Coca-Cola Sign of Good Taste, 10, \$160.49
M-019-999, Pepsi=Cola, 6, \$46.09	M-171-001, Budweiser, 8, \$24.99	N-032-001, Budweiser (MIB) (BIN), 10, \$49.95	O-002-999, Gold Coast Creamy Root Beer, 10, \$60.89
M-019-999, Pepsi=Cola, 6, \$66.00	M-509-999, C&C Super Ginger Ale, 6, \$103.00	N-036-002, Budweiser, 6, \$9.00	O-002-999, Kist Root Beer, 6, \$48.67
M-019-999, Pepsi=Cola, 6, \$41.01	M-509-999, Drink Super C&C Ginger Ale, 6, \$16.91	N-036-007, Narragansett, 6, \$71.03	O-002-999, Kist Soda, 8, \$57.00
M-019-999, Pepsi=Cola (MIB), 10, \$88.00	N-002-001, Dixie, 8, \$12.99	N-036-UL, Grain Belt Beer Bemidji Distributing, 6, \$66.00	O-002-999, Lemmy Lemoande, 8, \$152.50
M-019-999, Pepsi=Cola (MIB), 10, \$56.00	N-002-001, Dixie (5 Examples), 4, \$50.09	N-038-001, Leinenkugel, 6, \$51.99	O-002-999, Mason's Root Beer, 10, \$170.27
M-019-999, Schroeder Hotels, 8, \$26.99	N-002-001, Dixie (Gold), 6, \$21.50	N-039-004, Storz, 8, \$15.00	O-002-999, Natural Seven Natural Seven, 10, \$89.00
M-019-999, Tiffany & Co, 6, \$35.45	N-002-001, Dixie (Red), 6, \$11.49	N-039-004, Storz (White), 8, \$9.99	O-002-999, Natural Seven Natural Seven, 10, \$89.00
M-019-999, Tripoli / Milwaukee, 8, \$48.51	N-002-001, Dixie (Red), 8, \$24.99	N-039-006, Storz, 6, \$15.00	O-002-999, Orange Crush (Orange Background), 10, \$150.00
M-021-001, Rainier, 6, \$31.09	N-002-001, Dixie (Red), 6, \$21.50	N-039-008, Storz (Green), 8, \$12.27	O-002-999, Orange Crush (Orange Background), 10, \$150.00
M-025-001, Lemp, 6, \$38.00	N-002-001, Dixie (Red), 10, \$27.99	N-039-008, Storz (Yellow), 8, \$15.50	O-002-999, Orange Crush (Orange Background), 10, \$157.50
M-025-001, Lemp, 8, \$51.50	N-003-UL, Grain Belt Beer Bud Andrews, 10, \$19.49	N-039-011, Storz, 6, \$15.00	O-002-999, Pinky's Mobil Gas, 8, \$32.31
M-025-001, Lemp, 6, \$72.78	N-004-001, Haberle, 6, \$45.00	N-040-010, Pabst, 6, \$23.59	O-002-999, Red Rock Cola, 8, \$45.00
M-025-001, Lemp, 6, \$36.97	N-004-002, Star Wooden Shoe, 8, \$40.00	N-040-030, Lone Star, 8, \$24.00	O-002-999, Robinson's Hybrid Seed Corn Bags, 8, \$32.99
M-025-001, Lemp, 6, \$49.99	N-004-003, Congress, 8, \$49.99	N-040-033, Point, 8, \$30.00	O-002-999, Smile, 8, \$22.00
M-025-001, Lemp, 6, \$54.99	N-004-999, 1933 Chicago WFs, 8, \$26.00	N-040-UL, Coors Light (Mountain Scene), 8, \$0.99	O-002-999, Sprint Soda, 10, \$49.99
M-025-001, Lemp, 6, \$20.50	N-004-999, 1933 Chicago WFs (Blue), 8, \$76.00	N-043-005, Hamm's, 8, \$27.00	O-002-999, Vess Draft Style Root Beer, 8, \$112.50
M-025-001, Lemp, 6, \$37.00	N-004-999, Boston Drug Co, 6, \$23.50	N-044-CAN, Kuntz Brewery Limited, 8, \$112.50	O-003-001, Scheidt (MIB), 10, \$15.00
M-025-001, Lemp, 6, \$137.50	N-004-999, Congress Scene (Schrade Knife), 8, \$89.00	N-048-001, Scheidt Valley Forge (MIP), 10, \$47.00	O-004-011, Champagne Velvet, 6, \$42.41
M-025-001, Lemp, 6, \$39.00	N-004-999, Rock Spring Water, 6, \$32.69	N-049-001, Pfaffs, 8, \$127.50	O-004-013, Miller, 6, \$41.00
M-025-001, Lemp, 6, \$44.99	N-005-001, West End, 6, \$41.00	N-050-003, Muehlebach, 6, \$44.99	O-004-016, Griesedieck Bros Var B, 6, \$55.00
M-025-001, Lemp (BIN), 6, \$40.00	N-005-001, West End, 6, \$27.26	N-069-001, Storz, 8, \$24.99	O-004-999, Squirt (In Logo), 4, \$48.99
M-025-001, Lemp (w/ L-2 James Pepper Whiskey), 6, \$102.50	N-006-001, Lembeck & Betz (Broken Blade), 4, \$77.43	N-070-UL, Bellaire Brewing Co Bellaire OH (w/ 2 Misc), 6, \$40.00	O-004-UL, Berghoff Products Co, 4, \$67.66
M-025-001, Lemp Var C, 6, \$43.00	N-008-001, Schuster (DNMR), 6, \$76.01	N-072-002, Miller (w/ 3 Misc), 6, \$34.00	O-005-003, Dixie 45, 6, \$39.00
M-025-999, Brown-Forman, 4, \$22.31	N-009-046, Fitger, 6, \$26.98	N-079-001, Simon Pure, 6, \$25.00	O-005-003, Dixie 45, 4, \$26.01
M-025-999, Brown-Forsman, 6, \$50.00	N-009-054, Pabst Fitgers, 6, \$10.72	N-085-999, The Famous Utica Beer, 6, \$34.67	O-005-003, Dixie 45 (MIB), 10, \$36.00
M-025-999, Old Forester, 6, \$48.00	N-009-999, Clicquot Mixers Bottled By Pepsi-Cola Bottling Co., 6, \$37.00	N-088-001, Dixie, 8, \$25.00	O-005-006, Jackson, 4, \$45.99
M-026-UL, Mahan Supply Co Kansas City, 6, \$30.00	N-009-999, Pepsi-Cola (Block) Bottling Co Aberdeen Washington, 6, \$25.00	N-088-001, Dixie, 8, \$29.99	O-005-006, Jackson, 6, \$46.00
M-027-001, Lone Star, 8, \$20.50	N-009-999, Pepsi-Cola (Block) Bottling Co Aberdeen Washington, 6, \$25.00	N-122-001, Pabst, 8, \$27.00	O-005-007, Lucky Lager, 8, \$17.38
M-027-001, Lone Star, 8, \$26.01	N-009-UL, Stoney's America's Best Beer Smithton PA, 6, \$11.05	N-148-009, Tosetti, 6, \$13.49	O-005-007, Lucky Lager, 8, \$32.75
M-027-001, Lone Star, 8, \$27.95	N-010-003, Koehler, 6, \$31.10	N-40-UL, Fort Collins Brewery, 8, \$7.29	O-005-007, Lucky Lager (MIB), 10, \$11.00
M-027-001, Lone Star, 8, \$28.77	N-011-001, Fort Pitt, 6, \$9.99	N-502-999, Chero-Cola Fob, 2, \$20.19	O-005-009, Falstaff, 8, \$26.50
M-027-001, Lone Star, 8, \$36.07	N-011-003, Falstaff, 6, \$20.50	N-505-999, Coca-Cola Nashville 1952, 6, \$21.50	O-005-009, Falstaff, 6, \$22.01
M-027-001, Lone Star, 8, \$38.00	N-011-999, 1933 Chicago WFs, 6, \$20.50	N-506-999, Coca-Cola In Bottles, 8, \$39.99	O-005-010, Southern Select (MIB), 10, \$26.00
M-027-001, Lone Star, 8, \$37.17	N-013-002, National Baltimore Orioles, 6, \$23.28	N-506-999, Coca-Cola In Bottles, 8, \$46.01	O-005-010, Southern Select (MIB), 10, \$26.50
M-027-001, Lone Star, 8, \$38.17	N-018-001, Chief Oshkosh, 8, \$10.51	N-506-999, Coca-Cola In Bottles, 6, \$41.00	O-005-011, Acme, 8, \$46.25
M-027-001, Lone Star, 8, \$40.05	N-020-001, Birk Bros, 8, \$29.99	N-506-999, Coca-Cola In Bottles, 6, \$52.00	O-005-011, Acme, 4, \$56.05
M-027-001, Lone Star, 8, \$28.00	N-021-001, Anheuser-Busch, 4, \$78.15	O-001-UL, Walters Eau Claire Wisc, 8, \$293.00	O-005-011, Acme (BIN), 8, \$35.00
M-027-001, Lone Star, 8, \$28.00	N-022-009, Fredericks, 8, \$61.60	O-002-001, Simon Pure, 8, \$58.78	O-005-014, Simon Pure, 6, \$22.72
M-027-001, Lone Star, 8, \$25.22	N-024-001, Stag, 6, \$19.99	O-002-002, Columbia, 8, \$31.00	O-005-014, Simon Pure (MIB), 10, \$42.77
M-027-001, Lone Star, 8, \$28.00	N-025-007, Pearl, 6, \$14.16	O-002-002, Columbia, 8, \$45.00	O-005-015, Stegmaier, 8, \$32.00
M-027-001, Lone Star, 8, \$28.00		O-002-003, Flecks, 8, \$15.50	O-005-016, Sterling, 6, \$34.99
M-027-001, Lone Star, 8, \$23.00		O-002-003, Flecks, 8, \$56.00	O-005-016, Sterling, 6, \$41.99
M-027-001, Lone Star, 8, \$42.23		O-002-003, Flecks Beverages, 10, \$43.95	O-005-016, Sterling, 4, \$58.35
M-029-054, Hamm's (MIB), 10, \$41.00		O-002-006, Schlitz Heileman, 8, \$66.77	O-005-018, Falstaff (MIB), 10, \$20.49
M-029-999, Floating Fish Co Richmond VA, 8, \$32.56		O-002-010, Jung, 6, \$100.00	O-005-023, Regal, 6, \$43.00
M-029-999, Royal Crown Cola Bowling Green KY, 8, \$10.19		O-002-015, Standard, 6, \$48.67	O-005-028, Miller, 6, \$100.00
M-030-999, Pepsi-Cola Bottling Co Flat River MO, 6, \$31.54			
M-046-001, Busch Bavarian, 8, \$23.49			
M-053-001, Schlitz, 8, \$10.49			
M-065-001, Bub, 6, \$26.00			
M-073-001, Missoula (Blue), 8, \$260.00			
M-073-005, Kessler, 6, \$146.94			
M-073-012, Kessler, 4, \$100.00			

"Opener and eBay Trivia" ("BIN" Buy-It-Now & "DNMR" Did Not Meet Reserve)

O-005-999, Bank's Beer, 6, \$26.00	\$231.61	P-008-052, Houston, 6, \$39.00	P-026-011, Anheuser-Busch (Steel), 2, \$89.99
O-005-999, Climax, 2, \$29.00	O-006-UL, National Bohemian Beer Mr BOH, 8, \$178.51	P-008-065, Atlanta / Astoria, 6, \$48.00	P-026-017, Bergner & Engel, 8, \$333.00
O-005-999, Coca-Cola (Painted All Red), 2, \$50.00	O-006-UL, National Bohemian Mr BOH, 10, \$203.88	P-008-073, Lemp, 8, \$80.00	P-026-018, Anheuser-Busch 125th (MIB), 10, \$76.55
O-005-999, Crosley, 6, \$39.00	O-006-UL, Pearl Lager Beer, 6, \$89.88	P-008-074, C&J Michel, 8, \$51.00	P-026-018, Budweiser 125th Anniversary, 10, \$108.00
O-005-999, Crosley, 6, \$39.00	O-008-009, Blatz, 6, \$23.53	P-008-086, Atlanta, 6, \$30.99	P-026-999, Blankenhorn & Co Champagne / Sportsman, 6, \$157.48
O-005-999, Crosley, 4, \$28.65	O-008-999, Coca-Cola McEldowney Bros Altoona PA, 2, \$48.78	P-008-196, Toledo, 6, \$175.00	P-034-001, Schlitz, 4, \$53.00
O-005-999, Double Cola, 4, \$30.00	O-008-999, Polar Ginger Ale Worcester MA, 6, \$27.00	P-008-200, Tennessee, 6, \$78.88	P-034-002, Schlitz, 8, \$400.00
O-005-999, Dr Pepper, 6, \$31.00	O-008-UL, Burkhardt's Beer, 6, \$48.78	P-008-999, Macrisco and Lakewood Beverages, 6, \$41.00	P-035-999, "New Unique" (Rusty), 2, \$158.52
O-005-999, Dr Pepper Good For Life, 6, \$33.00	O-012-001, Pabst, 6, \$255.00	P-009-001, Heim, 6, \$26.00	P-036-002, Metz, 8, \$20.50
O-005-999, Dr Pepper Good For Life, 6, \$45.44	O-014-UL, Fleck's Beer, 8, \$9.51	P-009-015, Lutz, 6, \$30.00	P-036-002, Metz, 8, \$18.00
O-005-999, Dr Pepper Good For Life, 4, \$26.49	O-016-999, Cheer Up, 6, \$36.00	P-009-022, Virginia, 6, \$240.06	P-036-999, Hamm's Beer Diamond Spring Beverage Co, 8, \$152.50
O-005-999, Enjoy Red Rock Cola, 6, \$46.95	O-016-999, Coca-Cola, 8, \$42.89	P-011-999, Tip-Top, 8, \$42.00	P-036-UL, Hamm's Beer, 2, \$7.60
O-005-999, Enjoy Red Rock Cola, 8, \$128.50	O-016-999, Coca-Cola, 8, \$29.99	P-013-001, Schlitz, 2, \$38.00	P-037-001, Mound City, 6, \$15.91
O-005-999, Frigidaire, 6, \$97.99	O-017-001, Rolling Rock, 8, \$41.25	P-013-001, Schlitz, 6, \$72.60	P-038-001, Anheuser-Busch, 6, \$261.00
O-005-999, Frigidaire, 4, \$56.00	O-018-999, Coca-Cola, 4, \$79.89	P-013-001, Schlitz, 6, \$75.00	P-044-001, Bartholomay, 6, \$69.00
O-005-999, Grapette, 4, \$41.00	O-019-999, Country Club Soda Springfield MA, 6, \$18.10	P-014-001, Blatz, 6, \$18.50	P-051-017, Minneapolis, 6, \$25.55
O-005-999, Grapette, 4, \$43.00	O-502-999, Coca-Cola, 6, \$430.99	P-014-003, Metz, 6, \$22.49	P-051-018, Obert, 6, \$34.99
O-005-999, Grapette, 2, \$27.00	O-502-999, Coca-Cola (Covered in White Paint), 2, \$359.44	P-014-003, Metz, 8, \$29.99	P-051-022, Spokane, 6, \$39.00
O-005-999, Kelvinator, 6, \$152.50	O-502-999, The Liquid, 4, \$26.51	P-014-010, Regal, 8, \$16.01	P-051-030, Heileman, 8, \$76.50
O-005-999, Kist Soda, 8, \$26.53	O-502-999, The Liquid, 4, \$23.50	P-014-019, Pabst, 6, \$24.75	P-051-033, Neef Bros, 8, \$22.05
O-005-999, Nehi, 6, \$63.45	O-505-999, Coca-Cola, 8, \$41.00	P-015-UL, Walters & Blatz Beer Stanley Bottling (Missing Cork-screw), 2, \$56.20	P-051-033, Neef Bros, 8, \$70.00
O-005-999, Nehi, 4, \$127.85	O-505-999, Coca-Cola (4 Examples), 6, \$45.00	P-016-001, Narragansett (Best Offer), 6, \$35.00	P-051-037, Neef Bros, 8, \$52.00
O-005-999, Orange Crush, 6, \$39.99	O-505-999, Drink Mavis, 6, \$43.00	P-016-001, Narragansett (Both Blades Broken), 2, \$124.50	P-051-043, Bechtel, 6, \$26.00
O-005-999, Pelco, 2, \$228.50	O-505-999, Mavis, 6, \$49.19	P-017-015, Dallas, 6, \$41.00	P-054-009, Home Richmond, 4, \$19.99
O-005-999, Pep, 8, \$69.76	O-505-999, Mavis, 6, \$76.00	P-019-002, Townsend, 8, \$14.99	P-054-016, Popel-Giller, 6, \$53.00
O-005-999, Polar, 8, \$81.69	O-505-999, Nehi, 8, \$113.50	P-019-035, Schiller, 6, \$18.27	P-054-021, Kittanning, 8, \$26.88
O-005-999, R C Cola, 6, \$23.00	O-505-999, Orange Crush, 6, \$33.00	P-019-037, Fehr (BIN), 8, \$35.00	P-054-023, Eagle Malt, 8, \$24.99
O-005-999, Sidral Mundel (Not Made by Brown Mfg), 6, \$102.72	O-505-999, Orange Crush, 2, \$52.55	P-019-059, Narragansett, 6, \$9.99	P-054-999, Rockwell Clough, 8, \$152.50
O-005-999, Squirt, 6, \$31.00	O-505-999, Orange Crush, 6, \$31.26	P-019-108, Pabst, 8, \$31.00	P-054-UL, Fred Bauernschmidt Beer Baltimore MD (w/ 1 Misc), 6, \$26.51
O-005-999, Squirt (MIB), 10, \$32.50	O-505-999, Whistle, 8, \$99.99	P-019-999, Hayner Whiskey (Lot of 40), 8, \$207.50	P-057-001, Ionia, 6, \$57.00
O-006-007, Arrow, 8, \$78.01	O-507-999, Pepsi=Cola, 8, \$62.50	P-019-999, Hill & Barns Lynchburg VA, 8, \$53.00	P-057-004, Minneapolis, 6, \$38.51
O-006-009, National, 8, \$168.63	O-507-999, Pepsi=Cola, 6, \$45.65	P-019-999, Silver King Bar Belton Texas, 8, \$126.48	P-057-010, Blatz, 8, \$52.00
O-006-999, Buckeye Root Beer, 8, \$91.09	O-507-999, Pepsi=Cola, 6, \$49.00	P-019-999, X L Saloon Farmington NH, 6, \$34.75	P-057-012, Columbia, 6, \$31.00
O-006-999, Coca-Cola, 6, \$66.26	O-507-999, Pepsi=Cola, 6, \$42.51	P-019-UL, Anheuser-Busch Council Bluffs Iowa, 6, \$84.00	P-057-017, Minneapolis, 8, \$95.00
O-006-999, Coca-Cola, 8, \$89.93	O-507-999, Pepsi=Cola, 6, \$39.55	P-019-UL, Henco Brewery Spokane WA, 6, \$159.49	P-057-021, Texas, 4, \$30.01
O-006-999, Coca-Cola, 8, \$133.98	O-508-999, Nesbitts, 6, \$17.00	P-022-005, Engesser, 6, \$137.50	P-057-037, Wacker & Birk, 8, \$49.00
O-006-999, Donald Duck (Pic of Donald Duck) Soft Drinks, 10, \$283.00	O-508-999, Pepsi=Cola, 6, \$24.99	P-022-010, Moerlein, 8, \$40.00	P-070-001, Minneapolis, 6, \$61.99
O-006-999, Dr Pepper, 8, \$52.00	O-508-999, Pepsi=Cola, 6, \$40.00	P-023-003, Old Style, 6, \$23.50	P-070-001, Minneapolis, 6, \$107.50
O-006-999, Drink Frostie You'll Love It, 6, \$26.51	O-508-999, Pepsi=Cola, 6, \$41.00	P-024-003, Excelsior, 8, \$25.15	P-085-001, Henning, 6, \$41.01
O-006-999, Drink Smile, 8, \$168.27	O-509-999, 7Up, 8, \$63.25	P-024-007, Strohs / (Add Same), 6, \$21.05	P-109-001, Popel-Giller, 8, \$116.49
O-006-999, Lively Limes, 10, \$128.40	O-509-999, Dr Pepper, 8, \$359.00	P-025-002, Anheuser-Busch, 6, \$2,222.00	P-165-999, 1941 Press Club Brooklyn Dodgers Football, 8, \$62.00
O-006-999, Mac's Root Beer (Logo), 6, \$59.54	O-509-999, Nehi, 8, \$77.25	P-025-002, Budweiser (Missing Blade) (BIN), 2, \$375.00	P-503-999, Clicquot Club (Brass), 6, \$87.20
O-006-999, Marine Club Ginger Ale (Pic of Boat), 10, \$89.99	O-515-999, Coca-Cola, 8, \$27.78	P-025-003, Anheuser-Busch (Kastor), 6, \$258.00	P-503-999, Clicquot Club (Bronze), 6, \$77.00
O-006-999, Orange Crush, 10, \$163.59	O-515-999, Coca-Cola (MIB), 10, \$43.00	P-025-003, Anheuser-Busch (MIP Pouch), 10, \$152.50	P-503-999, Clicquot Club (Copper), 6, \$68.00
O-006-999, Pepsi=Cola (In Bottle Cap), 8, \$130.38	O-516-999, Coca-Cola, 8, \$115.07	P-025-003, Anheuser-Busch Schrade-Walden, 8, \$153.75	P-511-999, Jack Daniels, 8, \$63.88
O-006-999, Pepsi=Cola (On Bottle Cap), 8, \$122.99	O-516-999, Wilcox Mfg, 8, \$71.00	P-025-004, Anheuser-Busch (w/ Pouch) (Rusty), 2, \$180.50	P-514-999, Coca-Cola (Fantasy), 8, \$69.00
O-006-999, Pepsi=Cola (On Bottle Cap), 8, \$79.00	O-520-999, 7Up Minars Seven-Up Co Fergus Falls MN, 4, \$1.99	P-025-011, Anheuser-Busch (Blue), 4, \$380.00	Q-008-015, Pabst, 6, \$12.50
O-006-999, Reed & Bell Root Beer (Logo), 8, \$103.49	O-522-999, Nehi, 6, \$77.00	P-025-CAN, C N Huether Berlin Ontario Brewery, 6, \$433.00	R-003-001, Iroquois, 6, \$15.50
O-006-999, Royal Crown Cola, 8, \$46.27	O-522-999, The Arcade Mfg Co, 6, \$30.18	P-025-UL, Buffalo Brewing Co (Pic of Lady), 6, \$189.50	R-003-001, Iroquois, 8, \$34.21
O-006-UL, BOH Bohemian Lager Beer de-light-ful (Pic of hat), 10, \$92.26	P-001-006, Strohs, 4, \$103.05	P-026-003, Dick Brothers, 2, \$89.88	R-003-001, Iroquois (Some Paint), 6, \$19.05
O-006-UL, Esslinger (Pic of Waiter), 8, \$178.50	P-003-001, Pabst, 6, \$74.29	P-026-007, Dicks, 4, \$191.50	R-005-001, Schlitz, 8, \$22.00
O-006-UL, Grand Prize Lager, 6, \$52.15	P-003-001, Pabst, 6, \$51.99	P-026-008, Anheuser-Busch (Steel), 8, \$300.00	R-007-001, Hauenstein, 6, \$27.50
O-006-UL, Grand Prize Lager Beer, 6, \$55.67	P-003-002, American (BIN), 6, \$125.00	P-026-008, Anheuser-Busch (Steel), 8, \$300.00	R-007-001, Hauenstein, 8, \$88.91
O-006-UL, Gunther's Beer, 8, \$146.40	P-004-999, Blank (No Ad), 6, \$32.00	P-026-008, Anheuser-Busch (Steel), 8, \$300.00	R-008-001, Kaier (FBOC-405 Miner), 6, \$350.00
O-006-UL, Krueger's Beer & Ale, 8, \$231.61	P-005-001, Anheuser-Busch, 6, \$32.50	P-026-003, Dick Brothers, 2, \$89.88	R-027-001, Budweiser (MIB), 10, \$15.51
	P-005-001, Anheuser-Busch, 6, \$45.00	P-026-007, Dicks, 4, \$191.50	R-065-001, Miller, 10, \$20.00
	P-005-999, Jos Leopold & Bros Belleville IL, 6, \$18.50	P-026-008, Anheuser-Busch (Steel), 8, \$300.00	R-065-001, Miller, 8, \$8.00
	P-007-002, Smith, 6, \$40.00	P-026-011, Anheuser-Busch (Pearl), 4, \$152.50	T-002-002, Michelob, 8, \$16.01
	P-007-021, Burkhardt, 8, \$52.00		X-004-001, JFO 1989 Frankenmuth MI,
	P-007-025, Leisy (Missing Cork-screw), 4, \$31.00		
	P-007-048, Fenway, 6, \$46.00		
	P-007-UL, Barthe & Becker Whiskey Rainier Beer, 6, \$4.99		
	P-008-024, McAvoy, 8, \$24.95		
	P-008-045, Houston, 4, \$38.78		
	P-008-049, Gehling, 6, \$52.00		

“Opener and eBay Trivia” (“BIN” Buy-It-Now & “DNMR” Did Not Meet Reserve)

8, \$9.99	\$1,724.95	Z-Corkscrew, German 19thC Rasch Patent, 8, \$1,000.00	mount, 4, \$237.50
X-004-001, JFO 1989 Frankenmuth MI, 8, \$18.05	Z-Corkscrew, English 19thC Thomason w/ Badge Marked Joseph Fitter, 8, \$2,415.90	Z-Corkscrew, German 20thC Old Crow Figural Corkscrew (BIN), 6, \$300.00	Z-Corkscrew, US 20thC Blackington Sterling Golf Bag, 8, \$250.00
X-005-001, JFO 1990 Durham NC, 8, \$14.00	Z-Corkscrew, English 19thC Weir Double Rack Patent, 6, \$1,721.31	Z-Corkscrew, Italian 19thC Sterling Lady Handle Perfume Bottle Corkscrew, 8, \$1,941.17	Z-Corkscrew, US 20thC Boyer Hammer, 8, \$80.42
X-005-001, JFO 1990 Durham NC, 8, \$19.05	Z-Corkscrew, English 19thC Wilmot & Roberts Kings Screw, 6, \$705.00	Z-Corkscrew, Spanish 20thC Mechanical Concertina, 6, \$552.22	Z-Corkscrew, US 20thC Brownbilt Shoes Knife, 8, \$150.50
X-006-001, JFO 1991 RTP NC, 8, \$14.00	Z-Corkscrew, French 1830 Deleuz Champagne Tap Patent (Ornate), 8, \$2,800.00	Z-Corkscrew, Swedish 19thC Wood-T w/ Speed Worm, 8, \$665.00	Z-Corkscrew, US 20thC E-Z Cork Puller St Louis Rack, 8, \$1,137.00
Z-Can-Opener, British 19thC Cast Iron w/ Corkscrew, 6, \$366.13	Z-Corkscrew, French 19th Perille Perle (Pea Pod), 6, \$250.00	Z-Corkscrew, US 1876 Williamson Power Cone, 4, \$178.48	Z-Corkscrew, US 20thC Sterling Golf Bag by Blackington, 8, \$160.27
Z-Corkscrew, 1873 Barnes Patent Can Opener Corkscrew, 6, \$565.99	Z-Corkscrew, German 1882 Valentin-Rasch Patent # 20,803, 8, \$4,184.78	Z-Corkscrew, US 1883 Strait Patent (Band Split), 4, \$314.00	Z-Corkscrew, US 20thC Syroco Clown (Painted), 8, \$1,150.00
Z-Corkscrew, Austrian 1908 Hudzikowski Double Lever Patent, 8, \$2,000.00	Z-Corkscrew, German 1890s Hollweg Miniature 1", 8, \$332.20	Z-Corkscrew, US 1884 Curley Metal-T Handle Patent, 6, \$665.55	Z-Corkscrew, US 20thC Syroco Indian, 6, \$850.00
Z-Corkscrew, Chinese Girl Figural w/ Corkscrew Attached to Back of Head, 6, \$245.05	Z-Corkscrew, German 1920s Trumpf Steel Frame Patent, 6, \$1,280.00	Z-Corkscrew, US 1884 Curley Metal-T Handle Patent (Short Pin), 4, \$359.00	Z-Corkscrew, US 20thC Syroco Indian, 8, \$750.01
Z-Corkscrew, English 1802 Thomason Patent (BIN), 8, \$425.00	Z-Corkscrew, German 19thC Austtossler Perpeutal, 8, \$553.21	Z-Corkscrew, US 1884 Curley Wood-T, 6, \$179.00	Z-Corkscrew, US 20thC Syroco Indian (Chipped), 4, \$710.00
Z-Corkscrew, English 19thC BB Wells Winged Nut, 8, \$3,857.66	Z-Corkscrew, German 19thC Celluloid Alligator Waiter's Friend, 6, \$675.00	Z-Corkscrew, US 1884 Griswold Wood-T Patent, 8, \$500.00	Z-Corkscrew, US 20thC Syroco Indian (Nose Chipped), 6, \$355.00
Z-Corkscrew, English 19thC Charles Hull Royal Club Patent, 6, \$2,266.00	Z-Corkscrew, German 19thC Celluloid Alligator Waiter's Friend, 8, \$635.00	Z-Corkscrew, US 1886 Hurley F F Adams Barmount, 6, \$561.00	Z-Corkscrew, US 20thC Syroco Laughing Man, 8, \$195.00
Z-Corkscrew, English 19thC Eyebrow T-Handle w/ 2 Spikes, 6, \$2,247.00	Z-Corkscrew, German 19thC Celluloid Folding lady, 6, \$510.01	Z-Corkscrew, US 1892 Mumford Cork Extractor (BIN), 6, \$150.00	Z-Corkscrew, US 20thC Syroco Monk (Painted), 8, \$240.27
Z-Corkscrew, English 19thC G F Hipkins & Sons Lever Rack, 6, \$3,383.33	Z-Corkscrew, German 19thC Celluloid Folding Lady, 6, \$510.01	Z-Corkscrew, US 1894 The Detroit Fancy Leg, 8, \$1,142.00	Z-Corkscrew, US 20thC Syroco Old Codger (Stained), 8, \$355.00
Z-Corkscrew, English 19thC G Twiggs Patent Wood T-Handle, 6, \$1,136.12	Z-Corkscrew, German 19thC Celluloid Folding Legs Blue Stripes, 6, \$379.99	Z-Corkscrew, US 1894 The Detroit Leg, 6, \$382.00	Z-Corkscrew, US 20thC Syroco Old Codger (Stained) (BIN), 8, \$100.00
Z-Corkscrew, English 19thC Kings 4-Post Mechanical, 8, \$550.00	Z-Corkscrew, German 19thC Celluloid Folding Legs Blue Stripes, 6, \$402.26	Z-Corkscrew, US 1894 The Detroit Welch's Juice Co, 6, \$228.50	Z-Corkscrew, US 20thC Syroco Waiter (Painted), 6, \$55.00
Z-Corkscrew, English 19thC Lund Patent Lever w/ Bronze Finish, 8, \$532.11	Z-Corkscrew, German 19thC Celluloid Folding Legs Flesh Tone, 6, \$460.00	Z-Corkscrew, US 1917 Brady "U-Neek" Patent (DNMR), 6, \$565.55	Z-Corkscrew, US 20thC Syroco Waiter (Stained), 8, \$92.67
Z-Corkscrew, English 19thC Lund Spherical Joint Roundlet, 8, \$240.00	Z-Corkscrew, German 19thC Celluloid Folding Legs Pink Stripes, 6, \$402.26	Z-Corkscrew, US 1917 Brady Uneek Patent (DNMR), 6, \$504.00	Z-Corkscrew, US 20thC Tiffany & Co 14K Beau Brummel Roundlet, 8, \$169.49
Z-Corkscrew, English 19thC Rotary Eclipse Barmount (Shipping \$136.00), 6, \$364.00	Z-Corkscrew, German 19thC Celluloid Folding Striped Legs Morgan Distilling KC, 8, \$355.00	Z-Corkscrew, US 1931 Charbonneau Patent (Bottle Sealer, Opener, Corkscrew), 8, \$123.62	Z-Corkscrew, US Leg Knife Brown Bilt Shoes, 8, \$164.00
Z-Corkscrew, English 19thC Steel Pocket w/ Faceted Handle, 6, \$423.24	Z-Corkscrew, German 19thC Celluloid Mermaid Waiter's Friend, 4, \$256.00	Z-Corkscrew, US 1948 Neal Patent (M-19 w/ Corkscrew), 6, \$76.00	Z-Corkscrew, US Syroco Indian (BIN), 8, \$1,100.00
Z-Corkscrew, English 19thC Thomason 3 1/2 Window Dowler, 8, \$1,300.00	Z-Corkscrew, German 19thC Celluloid Mermaid Waiter's Friend, 6, \$368.00	Z-Corkscrew, US 1949 Ross Patent Green Pig, 8, \$139.09	Z-Opener, (Wood Block w/ Nail) War Time Bottle Opener Starke FL, 6, \$78.97
Z-Corkscrew, English 19thC Thomason Barlow Patent, 6, \$426.00	Z-Corkscrew, German 19thC Celluloid Mermaid Waiter's Friend, 6, \$450.00	Z-Corkscrew, US 1949 Ross Patent Red Pig, 8, \$139.09	Z-Opener, US 1934 Chase "Squeezeit" Bottle Opener, 8, \$20.53
Z-Corkscrew, English 19thC Thomason II Windows Variant, 8, \$1,605.72	Z-Corkscrew, German 19thC Celluloid Mermaid Waiter's Friend (BIN), 6, \$450.00	Z-Corkscrew, US 1949 Ross Patent White Pig, 8, \$222.50	Z-Opener, US 1934 Chase "Squeezeit" Bottle Opener, 8, \$21.00
Z-Corkscrew, English 19thC Thomason Ultra (Robert Jones), 8,	Z-Corkscrew, German 19thC Celluloid Mermaid Waiter's Friend, 6, \$450.00	Z-Corkscrew, US 1949 Ross Patent Yellow Pig, 8, \$222.50	Z-Opener, US 1934 Chase "Squeezeit" Bottle Opener, 8, \$25.49
	Z-Corkscrew, German 19thC Celluloid Mermaid Waiter's Friend (BIN), 6, \$450.00	Z-Corkscrew, US 1949 Ross Patent Yellow Pig, 8, \$114.42	Z-Opener, US 1934 Chase "Squeezeit" Bottle Opener, 8, \$21.73
	Z-Corkscrew, German 19thC Celluloid Mermaid Waiter's Friend (BIN), 6, \$450.00	Z-Corkscrew, US 19thC Bishop & Babcock Barmount, 4, \$612.50	Z-Opener, US 1934 Chase "Squeezeit" Bottle Opener, 8, \$31.00
	Z-Corkscrew, German 19thC Celluloid Mermaid Waiter's Friend (BIN), 6, \$450.00	Z-Corkscrew, US 19thC Clough Medicine Dial, 6, \$372.00	
	Z-Corkscrew, German 19thC Celluloid Napier Sterling Silver, 8, \$445.00	Z-Corkscrew, US 19thC Pullmee Bar-	



A-17-25 Mischicott bought on a board (left) and then above after being removed and cleaned.

Opener and eBay Triviall (ICCA Auction Results Nov/2012)

EXTREMELY RARE SHRAPNEL 1839 BRITISH PATENT MARKED. \$25,200.00	Unusual Ratchet Corkscrew. (USD) \$3,638.23	Rare Vesta and Corkscrew by Asprey. (USD) \$2,105.85
RARE WHITE'S JULY 3. 1883 PATENT - MARKED. \$25,000.00	Ellis Collection - Rare Bateman Patent 1866. (USD) \$3,633.49	VERY RARE DEMMLER & BIES 1895 DRGM "ROYAL" MARKED. \$2,100.00
RARE GERMAN "COLUMBUS" - Only Known Example. \$21,600.00	Ellis Collection- Rare 1847 Registered Dray King's Screw. (USD) \$3,475.51	Delavinge. (USD) \$2,072.19
ONLY KNOWN EXAMPLE - CHARLES CHINNOCK AMERICAN PATENT, 1884. \$20,000.00	Very Rare!!! Stunning Engraved Thomason Corkscrew. (USD) \$3,475.51	RARE GERMAN CORKSCREW - TAPERED SPRING. (USD) \$2,005.35
GERMAN MECHANICAL LEVER - D.R.PATENT - ANGEMELDET - SOLINGEN. \$17,100.00	VERY RARE DECORATED THOMASON CORKSCREW. (USD) \$3,342.25	Twiggs. (USD) \$2,005.35
Bradnock's Magic Twist. \$8,700.00	Rare French 18th Century Gold Sheathed Corkscrew. (USD) \$3,342.25	RARE 18th CENTURY TINDER BOX - CORKSCREW. \$2,000.00
Philos Blake American Patent. \$8,000.00	VALENTINE RASCH LATER VERSION - NO ROLLERS. \$2,950.00	Robert Jones 1 Registered Design Corkscrew. \$1,910.00
CORKSCREW LE CRIC CAVATAPPI KORKENZIEHER TIRE-BOUCHON. (USD) \$7,352.94	Luterman Coll. - German Gas Pump - Reg # 569.802. \$2,900.00	TRUNK'S 1886 US PATENT CORKSCREW. \$1,850.00
Archimedes Corkscrew DRGM 81644 Earliest Version. (USD) \$6,398.10	RARE 4 Pillar Thomason LOOK CAREFULLY!!!!. (USD) \$2,827.80	Luterman Coll. - 19th Century Open Frame marked Underwood. \$1,800.00
UNIQUE Hull Royal Club..Hull V. (USD) \$6,176.94	Hootch Owl09 Hootch Owl From the Rolf Herrmann collection T. (USD) \$2,810.15	FIGURAL COMBINATION FIRE STEEL-CORKSCREW W/ PARTNER. \$1,800.00
G Twiggs's patent-Lifting Jack corkscrew..VERY RARE.. (USD) \$5,924.17	RARE ENGLISH CORKSCREW - WHELAN PATENT. (USD) \$2,808.82	Ernst Demmler registered No. 170.162 Feb.1.1901. (USD) \$1,739.30
Luterman Coll. - Rare German Corkscrew - Unusal Locking Ring. \$5,800.00	STUNNING FRENCH SILVER DELEUZE CHAMPAGNE TAP. (USD) \$2,764.61	rare Dutch 18th century silver pocket corkscrew. (USD) \$1,737.97
Whelan Hippkins. (USD) \$5,485.29	decorative sliding corkscrew. (USD) \$2,740.64	Lady Wiers Corkscrew. (USD) \$1,737.76
Ellis Coll- Rare Henshall with Autumn Fruits Harvest Shaft. (USD) \$5,213.27	VERY RARE 1904 KOEBELER DRGM - MARKED. \$2,550.00	1882 Valentin Rasch German Patent Corkscrew. (USD) \$1,737.76
Superb example of Newtons Ratchet corkscrew. (USD) \$5,055.29	Fancy Puddefoot THE DETROIT. \$2,501.00	English Thomason's Corkscrew. Rare Square Tablet. \$1,705.00
G F HIPKINS Lever Rack Corkscrew. (USD) \$4,897.33	VERY RARE DOUBLE HELIX CS. PAT 1910. \$2,500.00	RARE GERMAN WAITERS FRIEND - FISH. REG DESIGN #196.995. \$1,702.00
Unique brass mechanical corkscrew. (USD) \$4,897.31	Luterman Collection - German Gambrius D.R.G.M 137.497. \$2,500.00	a never used German Delavigne with all nickle plating. \$1,701.00
3 Pillar TWIGG Corkscrew RARE and Perfect.. (USD) \$4,739.34	THE DETROIT Fancy Leg - Puddefoot's 1894 US Patent Corkscrew. \$2,500.00	American Woodmans Patent Corkscrew. \$1,700.01
Early 18th century ram's head corkscrew by 'Fox'. (USD) \$4,739.34	Heeley RARE Compound Lever Dated 1880 (Wier's Model). \$2,500.00	Ellis Collection - Ebony Handle Silver Sheath Corkscrew. (USD) \$1,658.75
Rare 1899 DRGM "A. T. Co". \$4,600.00	Rare Silver Plated Ladies Legs corkscrew. (USD) \$2,406.42	Luterman Coll.- Joshua Barnes U.S. Patent Folding Bow. \$1,655.00
Fernand Francois L'Ultra Rapide Single Lever Corkscrew. (USD) \$4,581.36	RARE Large Brass Travel Corkscrew & Sheath 19th century. \$2,400.00	Twiggs and Bateman's English Patent No.956. (USD) \$1,604.28
ENGLISH G.F. HIPKINS PATENT - LEVER-RACK. \$4,572.00	Rare J.A.Henckels Side Rack and Pinion German Corkscrew. (USD) \$2,359.63	Ellis Collection- Rare 19th C. Iron Kings Screw. (USD) \$1,579.78
Totally UNIQUE Double folding cs with blade in spine!!!. (USD) \$4,344.39	Dutch 19th century silver folding bow. (USD) \$2,339.57	RARE- Very Early 2 pillar ENGLISH Corkscrew.. (USD) \$1,579.78
Very Rare Black Celluloid, Bewer's Amor Corkscrew. (USD) \$4,148.40	Fred O'Leary Collection: German Souvenir "Rifle". \$2,300.00	Etincelant. (USD) \$1,579.78
VALENTINE RASCH RARE LATER VERSION - NO ROLLERS. \$4,000.00	Original Thomason Variant Corkscrew - Superb!. (USD) \$2,290.68	S Pat Double Helix Corkscrew. (USD) \$1,556.08
BRADNOCK'S PATENT 1883, ENGLISH - MARKED. \$3,900.00	18th.c.Dutch Hallmarked Silver pocket corkscrew. (USD) \$2,272.73	19th Century Corkscrew - Horn Handle Carved With Bacchus. \$1,510.00
ANCIEN TIRE-BOUCHON 18EME SIECLE. (USD) \$3,877.01		Ellis Collection - Champagne Tap - Jones marked VR. (USD) \$1,500.79
		Fine 19th C English Fig. Coiled Snake Corkscrew Carved Tusk. \$1,500.00

Opener and eBay Triviall (ICCA Auction Results Nov/2012)

Very rare German Lautier DRGM, nickle plated. (USD) \$1,471.93	RARE Coney type II pillar, hidden gear mechanism. (USD) \$1,184.83	RARE GEORG JENSEN SILVER CS PYRAMIDE.. \$900.00
Very Very Rare German Lautier DRGM Corkscrew nickle plated. (USD) \$1,437.60	Rare Hugo Lautier 1896 German Corkscrew. (USD) \$1,136.36	ROBERT MURPHY - OPEN FRAME CORKSCREW - MARKED. \$900.00
Jacob Bunger Sohn Barmen WAITER'S FRIEND Corkscrew. (USD) \$1,426.54	X RARE RAZOR - KNIFE WITH CS CA 1930. \$1,100.00	MINIATURE JULES BRANG POCKET CORKSCREW. \$875.00
German registered 'dumbell' roundlet. (USD) \$1,423.38	Fred O'Leary Collection: Decorative Dutch Silver Folding Bow. \$1,100.00	Very RARE German Rival corkscrew Superb.. (USD) \$868.88
Ellis Collection - Rare German Kummer DRGM Meteor Corkscrew. (USD) \$1,421.80	Thomas Curley American Patent Variations. \$1,100.00	Ellis Collection - Rare Russell Patent Picnic Corkscrew 1921. (USD) \$868.88
Gothic Windows Thomason corkscrew. \$1,400.00	Early German Ehrhardt Patent Corkscrew. (USD) \$1,069.52	French Rack & Pinion Corkscrew by Pecquet. (USD) \$868.88
BARSCREW: KRICHAU'S 1883 GERMAN D.R.P.. \$1,395.00	RARE German Corkscrew - Wilhelm von & zur Gathen DRGM 35052.. (USD) \$1,016.04	Ellis Collection- Rare Ward Pat. Bottle Stopper Remover 1918. (USD) \$853.08
3.5 Window Thomason Great Piece Jack Webb Collection.... (USD) \$1,374.41	VERY RARE ITALIAN WALLMOUNT BREVETTATO - 50cm. \$1,000.00	ANDERS ANDERSON 1899 SWEDISH LADY KNIFE - MARKED. \$850.00
FOLDING HORSE LEGS CORK-SCREW - 1894 PATENT. \$1,350.01	FRENCH PERILLE FOLDING CORK-CREW. FULLY MARKED. \$1,000.00	MARKED - American 1895 Brown Patent - Short Frame (Rare). \$850.00
Ellis Collection French Bottle Shaped Folding Arms Corkscrew. (USD) \$1,342.81	Nice nicle plated Us Paten Tucker marked PAT SEP 3 1878. \$1,000.00	DESCOURS 1905 FRENCH PATENT - MARKED. \$825.00
RARE 4 pronged Henshal Marked " improved patent". (USD) \$1,327.01	Tucker's US patent single-lever corkscrew. \$1,000.00	WALKER'S MARCH 23, 1897 PATENT - RARE VARIENT. \$816.00
Rare Peg & Worm Corkscrew Compass Combination. (USD) \$1,279.62	HARTMAN 1887 GERMAN & BRITISH PATENT. \$1,000.00	GERMAN COMBINATION POCKET - W/POUCH, ca1900. \$813.00
Ellis Collection. - English Silver & Turquoise Roundlet 1883. (USD) \$1,263.82	18 TH CEN SWEDISH GUN TOOL WITH CS. VERY RARE.. \$1,000.00	GROPELLI ITALIAN CORKSCREW. (USD) \$802.14
SYROCO PAINTED CLOWN. \$1,250.00	1878 U.S. Patent Tucker Single Lever Corkscrew marked. \$1,000.00	Luterman Coll.- Rare 19th Century Folding Bow. \$800.00
Leveaux type lever Corkscrew unmarked SUPER!!!. (USD) \$1,248.03	Walter Dickson American Patent of 1870. \$1,000.00	Ellis Coll Rare Berkeley Reg. Henshall with Decorative Shaft. (USD) \$789.89
German mechanical corkscrew - TRUMPF. \$1,212.00	RARE German Paffrath marked corkscrew. (USD) \$995.26	Ellis Collection - Early Brass 2 Pillar Open Frame Corkscrew. (USD) \$789.89
Ernst Demmler perpetual and a brass barrel. (USD) \$1,203.21	Yankee No. 2 Bar Screw. Gilchrist U.S. 1907 Pat. Rare advtg.. \$995.00	Ellis Coll.-Woodstock Chatelaine with Tiny Folding Corkscrew. (USD) \$775.67
Ellis Collection Rare Henshall Improved Patent with 4 Prongs. (USD) \$1,200.63	Harvest Barrel Thomason corkscrew. \$975.00	Ellis Coll. - Knife Sharpener - Taft's US Pat. Handle 1874. (USD) \$766.19
UNIQUE SWEDISH FOLDING STEEL CS PAT 1901. \$1,200.00	Stunning brass sheathed corkscrew with Angel. (USD) \$965.24	Corkscrew - Flesh Coloured Legs. (USD) \$766.19
Luterman Coll. - Corkscrew with Cigar Cutter & Carriage Key. \$1,200.00	The Original Eclipse bar top screw working. (USD) \$963.67	Luterman Coll. - German Cigar Cutter, Knife Sharpener, Combo. \$763.00
Luterman Coll.-Stephen Procter English Patent Cork Etractor. \$1,200.00	Unusual Decorated Bow Corkscrew...NO Reserve!! (USD) \$947.87	Ellis Collection- Decorative Carriage Key Corkscrew in Box. (USD) \$750.39
THOMASON'S SINGLE THREAD CORKSCREW - UNMARKED. \$1,200.00	ANCIEN TIRE-BOUCHON 19EME. (USD) \$935.83	Traifor Single Lever Corkscrew - Boxed. (USD) \$750.39
18th CENTURY SILVER TRAVELING CORKSCREW - AGATE HANDLE. \$1,200.00	Robt Jones & Sons Corkgrip with Bone Handle. \$925.00	James Heeley BAKER Patent Double Lever Corkscrew. (USD) \$750.39
German "Magnet" 1902 Patent Corkscrew. \$1,200.00	Wier's Patent "Peerless". \$915.00	Luterman Collection - French Cork Extractor - Pat # 55.579. \$750.00
	MINIATURE LADIES LEGS BLUE AND WHITE STRIPES. \$900.01	ANCIEN COUPE MUSELET EN ARGENT MASSIF. (USD) \$736.63
	HAGENAUER BOXER - AUTHENTIC FULLY MARKED. \$900.00	Corkscrew - Rare Miniature Legs Dark Green & White. (USD) \$726.70
	SEGERSTROM SWEDISH ART KNIFE 10.3 cm PLUS TWO G / Ws. \$900.00	

Opener and eBay Triviall (ICCA Auction Results Nov/2012)

Luterman Collection - German Pocket Folding Corkscrew, \$720.00	Alligator-Carved antler corkscrew, \$650.00	Can Opener Corkscrew, (USD) \$592.42
Ellis Coll.-Carlo's 1905 US Patent Corkscrew & Cap Extractor, (USD) \$710.90	Luterman Coll. - 19th Cent English Silver Pocket Corkscrew, \$650.00	7 Tool Bow Corkscrew - Rare tool - Cartridge Extractor, (USD) \$592.42
Silver Small S Pat Double Helix Corkscrew, (USD) \$710.90	Luterman Collection - German Folding Shoes, \$650.00	18TH CENTURY DOUBLE FOLDING POCKET CORKSCREW, (USD) \$592.42
GERMAN POCKET FLASK c/w CORK-SCREW & CUP, \$706.56	Fred O'Leary Collection: British Figural Heron Ring Pull, \$650.00	Extra Large Double Helix Corkscrew, (USD) \$592.42
WEBER 1907 DRGM BACCHUS 5 - MARKED - RARE, \$700.00	Bone Handled King's Screw Corkscrew, \$650.00	Super Nickel Four Pillar Kingscrew, (USD) \$568.72
Dutch silver corkscrew ca 1800 with guirlandes L XVI, \$700.00	Ellis Coll. - Champagne Tap with Drop Point Storage Ends, (USD) \$639.81	ANCIEN TIRE-BOUCHON PUBLICITAIRE « MUMM » ART NOUVEAU, (USD) \$568.18
Fred O'Leary Collection: French "4-Suits" T-Screw, \$700.00	18th century silver barrel corkscrew, (USD) \$635.03	First Ten Years of CCCC Publications 1986 to 1996 - Bound, \$556.00
Fred O'Leary Collection: Demmler 1884 DRP Perpetual Barrel, \$700.00	Ellis Coll. - Silver Guilt Etui with Loop Handle Corkscrew, (USD) \$631.91	Luterman Coll.- American MacLean Patent Corkscrew, \$555.00
Rare 1899 George Jopson American Patent corkscrew!, \$700.00	UNIQUE CORK EXTRACTOR, \$620.00	C1898 Carl Brewer German Celluloid Corkscrew Penknife, (USD) \$552.92
Ellis Collection - Salutaris Corkscrew - Large, (USD) \$679.30	ANCIEN TIRE-BOUCHON XIXEME, (USD) \$614.97	Kings Screw Rack & Pinion - Robert Jones, (USD) \$552.92
1st WW 1917 TRENCH ART BRASS LADIES LEGS CORKSCREW, (USD) \$668.45	GEORG JENSEN SILVER PICNICK CS, DESIGNED CA 1933., \$605.00	C. A. ERICSSON ESKILSTUNA PATENTSOKT PRIMA NYSIVLER, \$550.00
R.A.Koeller replaceable worm Austrian corkscrew, (USD) \$668.45	Carved Stained Tusk Hndl Corkscrew w/ Silver Mount & Studs, \$605.00	BEAUTIFUL FIGURAL ART DECO BRASS CORKSCREW, \$550.00
Holborn Lever, (USD) \$668.45	Art Deco Scandinavian silver corkscrew, (USD) \$601.60	19 TH CEN MINIATURE CS.BONE HANDLE BRASS WORM., \$550.00
Ellis Collection - Celluloid Rabbit with Sheath, (USD) \$657.19	1880 Friedrich Kummer German Patent, \$600.00	
	U-NEEK Corkscrew Opener U.S. Patent Excellent Condition, \$600.00	
	Ellis Collection- Rare 1875 Registered	

Sometimes You Just Have To Be Persistent by John Stanley

In early June an unlisted A-1 malt opener from San Diego was put on eBay and I turned it over to Jeb Burruss to bid on as he loves A-1s. Wouldn't you know Jeb forgot to bid as he was tied up at work. Someone bought the lot for \$16 and change. The seller had listed it under Keys as the opener was in with 10 old door keys. Then the real luck began. The lot sold on June 9th and I



saved the listing information. After a week I first asked the seller if he would contact the buyer to see if the buyer would sell me the opener and got no response. It took a couple of weeks for me to figure out if I check the seller's feedback, the buyer would probably leave feedback and I could get his eBay ID. The buyer did leave feedback so I emailed him. Another three weeks went by when the buyer finally responded and said he was traveling but would see if he still had it when he got home. This was on July 14th and finally when I had heard nothing I emailed buyer again on August 7th to see if he had the opener and on August 13th he emailed and said, yes he had it and how much would I be willing to pay. I told him \$20 and on August 18th he said that was acceptable to him and he said I could send money using PayPal. So far we had been using eBay messaging and it does not show a person's real email address. So I needed his and sent an eBay email asking. His reply came back but eBay had overwritten the email with their standard message of "<email address removed per policy>". Well darn, so close but so far away. I emailed him and told him to try again but no response so then I sent mine as jfo @ mindspring.com . He finally responded outside of eBay using my email address. Through PayPal I sent the \$20 and he sent the opener, receipt certified. I finally got the opener on August 24th, the day I retired. Persistence did pay off but I had a lot of doubt the entire way.

JFO & Other Clubs/Conventions (Newsletter Name in Italics)

American Breweriana Association (ABA): *American Breweriana Journal* (bi-monthly) on breweriana collecting. Dues \$25.00/year. ABA, PO Box 595767, Fort Gratiot MI 48059-5767. **2013 Jun 11-16 – 32nd Annual ABA Convention – Sheraton Westport Saint Louis MO – ABA Members Only (Saturday Public Show).** Contact Jean Tiegs, E-Mail jtiegs@americanbreweriana.org

Brewery Collectibles Club of America (BCCA): *Beer Cans & Brewery Collectibles* (bi-monthly) on breweriana collecting with emphasis on Cans. Dues \$35.00/year (Add Initiation Fee of \$3). BCCA, 747 Merus Ct, Fenton MO 63026-2092. **2013 Aug 29-31 – BCCA Convention 43 – Grand Wayne Convention Center Ft Wayne IN – BCCA Members Only.** Contact Dave Gausepohl, Email beerdave@fusenet.

Canadian Brewerianist: *The Canadian Brewerianist* (10/year) on Canadian breweriana collecting. Dues \$25.00/year (US Funds). Loren Newman, 2978 Lakeview Trail, Bright's Grove, Ontario, CANADA, N0N 1C0. **2013 Aug 6-10 – Canadian Brewerianist Annual Convention – Holiday Inn Winnipeg Airport-Polo Park Winnipeg Manitoba – All Breweriana Collectors Welcomed.** Contact Larry Sherk, E-Mail larrysherk@hotmail.com, (416) 465-3386

Canadian Corkscrew Collectors Club (CCCC): *The Quarterly Worme* (quarterly) on corkscrew collecting. Dues \$48.00/year. Milt Becker, One Madison Street 5B, East Rutherford NJ 07073 (Make Check Payable to the Full Club Name)

East Coast Breweriana Association (ECBA): *The Keg* (quarterly) on breweriana collecting. Dues \$32.00/year. ECBA, PO Box 1392, Doylestown PA 18901. **2013 Jul 10-13 – 41st Annual ECBA Convention – Clarion "The Belle" Hotel New Castle DE – ECBA Members Only (Saturday Public Show).** Contact Larry Handy, E-Mail ohugo1@aol.com

Figural Bottle Opener Club (FBOC): *The Opener* (quarterly) on cast iron openers. Dues \$30.00/year. Darryl Miller, 321 S. Cedar St., Lititz, PA 17543 (dgmiller@dejazzd.com). **Annual FBOC Convention Holiday Inn Reading PA (2013 June 7-9).**

Just For Openers (JFO): *Just For Openers* (quarterly) on all areas of opener collecting. Dues \$20.00/year or FREE on the Internet (www.just-for-openers.org). John Stanley, PO Box 51008, Durham NC 27717-1008. **2013 Apr 10-14 – 35th Annual Just For Openers Convention – Holiday Inn Opryland Nashville TN – All Opener / Corkscrew / Breweriana Collectors Welcomed.** E-Mail jfo@mindspring.com

National Association Breweriana Advertising (NABA): *The Breweriana Collector* (quarterly) on breweriana collecting. Dues \$25.00/year. NABA, 340 E Ashland Ave, Mt Zion IL 62549 **2013 Jul 31-Aug 3 – 42nd Annual NABA Convention – Hyatt on Main Green Bay WI – NABA Members Only (Saturday Public Show).** E-Mail gbaley@comcast.net

SHOWS (Good Sources for Openers & Corkscrews)

2013 Mar 10 – Annual Spring Breweriana & Beer Can Show – Comfort Inn 72nd & I-80 Omaha NE – 9AM-3PM (6' Tables \$17 Each). Hospitality Room Saturday Night (3/10) hosted by the Cornhusker's Chapter of BCCA. Contact John Mlady (402) 345-7909

2013 Sep 20-22 – 31st Annual Midwest Breweriana Show – Comfort Inn 72nd-Grovers Sts Omaha NE – JFO Members Welcomed. Contact John Mlady (402) 345-7909 or Bill Baburek, (888) 569-7924 E-Mail bjbaburek@cox.net

2014 Feb 12-16 – 35th Annual Blue & Gray Breweriana Show – Ramada Inn 5324 Jefferson Davis Highway Fredricksburg VA – All JFO Members Welcomed. Contact: John Fisher, PO Box 953, Mechanicsville, MD 20659-0953. 301-290-1573 E-Mail burntwoods@verizon.net

Just For Openers 2012/2013 Membership Directory Updates
Just For Openers Current Members: 240 (New Member Numbers 1166-68)

#	Last Name	First	Spouse	Street	City	St	Zip	Phone	E-Mail	Opener Specialties
1167	Fellows	Dan	Dorothy	529 Eisenhower Ave	Janesville	WI	53545-1701	608-754-6071	hwy51collector@yahoo.com	US Beer & Soda, esp Wisconsin
811	Pinney (Address Change)	Dave	Dru Pearson	8223 N Camino de la Viola	Tuscon	AZ	85741-1154	520-572-4778	dave-cent@att.net	Beer & Soda Openers; Pinney Beverage Items
1168	Rice	Lance		4958 Mapleview Dr	Vermilion	OH	44089-1630	440-967-1255		US Beer Openers
1166	Russell	Matt		749 N Kalamazoo Ave	Marshall	MI	49068-1072	517-745-9951	ohiobeer@hotmail.com	All Breweriana from Ohio & Michigan

A very unusual combination Stove Lid Lifter, Corkscrew and Crown (Bottle) Opener that was offered on eBay (I did not record the sale price). Have any corkscrew collectors seen this combination before. Ad is for the Pacific Coast Coal Co. of Portland, Oregon. It is always great to get a rare piece in mint condition in the original box.

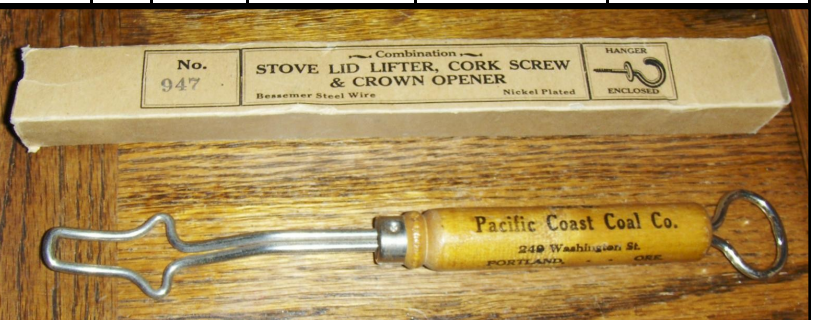

WANTED (Want & Sale Ads are FREE!!!!)

Openers: Golden Glow: A-1-9, B-23-149, E-14-787. Rainier: B-3-5, B-19-135, B-21-130, F-21-2, N-11-5 & 15, B-14-40 Salinas, C-21-8 Consumers, P-19-7, P-53-6, P-54-18. P-85s: 3,4,5,11,14. Also B-73-29 North Coast, G-28-66 Golden Gate Ale, G-99-11 Anderson Valley, N-89-2 Anchor Steam, O-13-1 & 2 Mendocino, Q-31-85 Bonnama (all colors), T-2-6 Anchor Steam. Also any Breweriana from Rainier (Seattle WA, LA CA, SF CA), Golden West (Oakland CA) & Port Townsend (WA). Buy/Trade. John Cartwright, 1548 Via Arroyo, Paso Robles CA 93446, (805) 712-6836 Email: jccm@charter.net

A-3-19 Stone Malt Akron. Great Trades or Buy. Jeb Burruss, 318 Lost Oak Dr, Canyon Lake TX 78133, (830) 899-7241

A-9-29 Waldorf, A-9-46 Tivoli, A-9-48 Bethlehem Malt 1/2 A-13-29 Fredericksburg, A-13-34 Fink, B-9-2 Salinas, B-9-10 Ambrosia, B-22s:8,17,27,49,59,67,68,74,77,92,95,112,113,116,118,123,133,140,142, B-31-11 Bellingham Bay, B-31-12 Salem, C-21-6 Grand Rapids, E-16-6 Moerlein, E-16-9 Maltosa, E-16-14 Beverwyck, E-18-2 Goetz & E-18-7 Portner, O-1-10 Glennon, G-3-1 Blatz, G-3-11 Fort Pitt, G-3-15 Eagle Malt, G-5s: 2,18,23,29,33,40,45,46,48,51,52, H-1s: 8,12,21,35,42,51, N-38-2 Springfield, N-38-4 Budweiser, O-1-2 Leidigers, O-1-6 Walters, O-1-10 Schmidt, O-1-11 Walter O-8s: #3,9,11,15,17,19,20,23,24, O-19-1 Bartels, O-22-2 Hennepin, O-8 O-10 O-19 O-22 w/ Soda Ads, John Stanley, PO Box 51008, Durham NC 27717, (919) 824-3046, Email jfo@mindspring.com

A-17 "Wilber Brewery" & P-8 "Omaha Brewing Association" (EX Condition Only). John Mlady, 1506 S 25th St, Omaha NE 68105-2611, (402) 345-7909

Openers with the word Saloon, Mexican A, B & D style Openers. Great Trades Available. Jack Ford, 5351 Boyd Ave, Oakland CA 94618, (510) 655-5393

B-2s #21 Fresno Local, #22 Haenle, #39 R. I. B., #40 Anheuser, B-1s #17 Furniture City, #18 Hohenadel, #19 Miller, #25 Liberty, #26 Phoenix, #30 Liberty Tamaqua. Bill Arber, 11162 Broadway St, Alden NY 14004-9515, (716) 681-4833, Email wraabra@aol.com

B-24-95 Flecks Beverages. Al Fleckenstein, 2445 NW Raleigh St, Portland OR 97210, (503) 223-0123, Email flecks@spiritone.com

B-45, B-66, I-7, P-72, P-100, R-14 types with a Corkscrew (Beer/Non-Beer). Herb Danziger, 550 Cherry Ct, Birmingham MI 48009-1459, (248) 646-9470

B-57, B-58, B-62, B-73, Q-10. Cash/Trade. Ben Hoffman, 213 Simmons Rd, Perkiomenville PA 18704, (610) 287-8243 or Email benbey@netcarrier.com

"E"s! Will Trade/Buy. Top 11 List: E-14-832 Uneeda, E-7-77 Lima, E-2-21 Park, E-3-30 Derby, E-4-207 Yosemite, E-4-244 Sequoia, E-4-245/300 Trainer, E-16-11 Ganser, E-17-9 Everett, E-17-7 I S D. Larry Moter, 10149 Michaels Rd, Woodford VA 22580, (804) 448-3928 E-Mail accneca@aol.com

I-7s Beer or Non-Beer. Hale Milano, 5300 Hillside Ln, Mechanicsburg PA 17050-2277, (717) 737-5067

I-7s Beer Openers #45 A-B Malt, #63 Diamond State, #64 Edel Brau, #84 Lion, #78 Malt Diastase, #81 Union Cream, #83 Williams: Will Pay Absolute Top \$\$\$ (Have I-7-40 Stroudsburg for Trade). Joe Todd, 5727 Bardsey Ct, Matthews NC 28104-0645, (704) 957-1658 Email Joseph.Todd@Protech-International.com

Bottle Shaped and/or Openers with Bottle on them. Gary Deachman, PO Box 438, North Woodstock NH 03262, (603) 745-2347

Wall Mounted Openers Wanted, all types (esp O-4, O-5 (esp Pabst), O-505, & O-515) John Eblen, 10113 Del Almendra Dr, Oakdale CA 95361, (209) 915-5445. E-Mail reggie2dog@msn.com

Corkscrews-Cork Pullers-Syroco (esp Golden Knight & Clown)-Early US Patents-Anything Unusual. Have Corkscrews to Trade or Buy. Please send description to Paul Luchsinger, 2815 King Rook Ct, Williamsburg VA 23185, (757) 345-3984, Email paulcork@cox.net

Corkscrews & Tin Can Openers: Beer Openers for Trade. Joe Young, 36 S Weston Ave, Elgin IL (847) 695-0108

Corkscrews & Postcards depicting Corkscrews. Please send description, photo, sketch, photocopy, or tracing of what you have & advise price wanted. Don Bull, PO Box 596, Wirtz VA 24184, (540) 721-1128, corkscrew@bullworks.net

Figural Corkscrews and any WASHINGTON D.C. Openers and/or Corkscrews. Sandra Emme, PO Box 1454, Upper Marlboro MD 20773, (301) 627-8207

Funeral Openers: Any opener with a Funeral Home ad. David Getz, PO Box 522, Ashland OH 44805, (419) 566-0391, balencur@yahoo.com

Hartford, Connecticut Openers & Breweriana Wanted, esp. E-8-61 Fischer & P-17-4 Columbia. Also general CT & New Eng. Beer Openers. Edward Johnson, 1300 Poquonock Ave, Windsor CT 06095

Illinois Openers and Illinois Breweriana. Buy-Sell-Trade. Dave Lendy, 1927 Allen Dr, Geneva IL 60134, (630) 715-2086, Email davidlendy@aol.com

Jamestown Brewing, Kuhn's Beer, Chautauqua Brew, Monessen PA, Independent Brewing, Schaefer, & all Cleveland Beers. Ed Schaefer, PO Box 149, Maple Springs NY 14756, Email eschaferbeer@juno.com

Joliet IL Openers: Citizens: B-14-97, C-17-69, E-1-32, E-3-12, E-4-175, K-5-6, O-10-1, P-121-1, Porter: A-17-24, B-18-594,618, B-21-199, F-6-9, Sehrings: B-21-561, G-9-39. John Bitterman, Email JEBitter@aol.com

Kamm & Schellinger Mishawaka Indiana Openers: A-28-74, B-18-40, B-18-85, B-21-114, F-6-132. Tim Maust, 10751 Ireland Rd, Osceola IN 46561, (574) 674-6814, Email tmaust@aol.com

L-1 Openers Wanted! Looking for both Beer or Consumer product advertising. Also looking for M1, M2, M3, M73 & Syroco Openers / Corkscrews. Tommy Campnell 869 E Schaumburg Rd Unit 254, Schaumburg IL 60194, (206) 612-7239, Email tommy.campnell@gmail.com

Minnesota Openers: A-21-63 Schatz-Brau, A-21-77 Otto, A-21-128 Hamm's, B-7-3 Hauenstein, B-7-22 Schells, B-13-2 Grain Belt, B-18-75 Standard, B-21-222 Bierbauer, B-21-370 Fitger, O-2-14 Royal Bohemian, O-4-4 Gluek. Pat Stambaugh, 718 S Lakeshore Dr, Lake City MN 55401, Email minn@mediacombb.net

Montana & Idaho Beer/Brewery Openers & Breweriana. Steve Armstrong, PO Box 741, Kamiah ID 83536, Email sunset@qroidaho.net

NEBRASKA OPENERS: Any with Nebraska towns or names & Esp Jetter Beer openers. Dick Schroeder, 3857 Calvalry Hills Dr, North Platte NE 69101, (308) 532-5597. Email dbschrod@charter.net

New York Openers: E-4-345 Koch, G-1-67 Hupfel. Will Buy/Trade. Mark Barren, 6141 Tachi Dr., Newfane NY 14108-9517, (716) 778-9724

Pinney Beverage Items Wanted: Pens & Pencils, Bottle & Can Openers, Any item with Pinney Beverage Company, Salt Lake City, Utah. Dave Pinney, 8223 N Camino de la Viola, Tuscon AZ 85741, (520) 572-4778, Email davecent@att.net

Wisconsin Brewery Openers: Knapstein, Hortonville, Princeton, Hochgreve, Bleser, Shawano & Rahr; esp A-17-27 Rahr. Dan Mayville, E7446 County Road H, Fremont WI 54940-9747

Have lists of East Coast beer & soda openers for sale. I can email scans or pictures of any opener. I will also trade for any Pennsylvania beer openers. John Fisher PO Box 953 Mechanicsville, MD 20659-0953 burntwoods@verizon.net

B-21 Key Style Opener with Ad for "American House Chicopee MA". Will pay \$200.00. Ferd Mireault, Email meyemessages@hotmail.com

Please visit the JFO website or Don Bull's website: www.just-for-openers.org or www.bullworks.net

Just For Openers	Jan/Oct Issue	Apr/Jul Issue	Apr/Jul Issue	Oct/Jan Issue
Newsletter Content	New Additions to Handbook	Membership Directory	Convention Highlights	New Discoveries
Articles	December 1st	June 1st	June 1st	December 1st
To Members By	January 31st	July 31st	July 31st	January 31st

Verne Vollrath Fixed Price List with some Special Variations

- 1) Email jfo@mindspring.com or call 919-824-3046 for any openers you want (you can make offers)
- 2) Any items you want will have your name reserving the piece until June 1st
- 3) Items with just one member wanting them as of the 1st are sold to that member at the listed price
- 4) On June 2nd any items that have more than one name wanting

- 5) the item will have members notified
- 6) Those members may then place a bid that is higher than the price (but you do not have to enter a bid)
- 7) If Bids are placed and tie bids are entered, members will be notified again to bid
- 8) Bids must be in by June 8th on any items with multiple names
- 9) Invoices will be sent on June 9th for all items
- 10) Shipping and Insurance will be additional
- 11) 7 Days to Return Items if NOT SATISFIED
- 12) Results will be shown in the April/July JFO issue

A-001-012, K & S (Kamm & Schellinger), IN, 4, \$15.00	A-005-010, Four Roses Malt, OH, 4, \$8.00	\$12.00	MT, 4, \$12.00
A-001-014, Maltop, NY, 6, \$12.00	A-005-012, National Buck, WI, 4, \$12.00	A-021-016, Atlas Kingsbury, XX, 6, \$15.00	A-029-033, Butte Bottlers Supply 112 & 114, MT, 4, \$12.00
A-001-021, El Capitan, CA, 6, \$15.00	A-005-015, Ideal, IA, 4, \$5.00	A-021-024, Gambrinus, IL, 4, \$15.00	A-029-038, Old Vienna, OH, 6, \$12.00
A-001-023, Grafts (Clothed), WI, 10, \$12.00	A-005-016, Zahringer Fossco, WI, 6, \$12.00	A-021-027, Pabst, WI, 4, \$18.00	A-029-044, Fox Head, IL, 6, \$12.00
A-001-024, Grafts Lemon-Life Beer (Clothed), WI, 6, \$15.00	A-005-016, Zahringer Malt, WI, 8, \$12.00	A-021-028, P O C, XX, 8, \$18.00	A-029-053, Oakley Malt, XX, 4, \$12.00
A-001-030, Fernie Beer (Canadian), XX, 6, \$10.00	A-005-033, O K Malt, WI, 6, \$12.00	A-021-029, Blatz, XX, 6, \$20.00	A-029-074, Veri-Best, NE, 6, \$15.00
A-001-032, Rexco Products, WI, 10, \$12.00	A-007-019, Bethlehem Malt, PA, 6, \$15.00	A-021-032, Renner, OH, 4, \$18.00	A-029-080, B & M Malt, XX, 4, \$15.00
A-001-034, Cascade, WA, 6, \$18.00	A-007-021, Manhattan, WI, 10, \$12.00	A-021-035, West Virginia, WV, 8, \$20.00	A-030-004, Schotts, IL, 4, \$18.00
A-001-051, Stone Malt, OH, 4, \$15.00	A-008-001, Ruppert, NY, 6, \$20.00	A-021-056, Hudepohl Wiedemann, OH, 6, \$18.00	A-030-007, Premier, MN, 2, \$18.00
A-001-052, Jamaica, WI, 10, \$15.00	A-009-004, Leisy, OH, 6, \$15.00	A-021-070, Blatz Pete, WI, 8, \$20.00	A-032-001, Wooden Shoe, OH, 8, \$20.00
A-001-055, Royal Canadian Malt, OH, 6, \$15.00	A-009-017, Schells, MN, 6, \$75.00	A-021-078, Rolling Rock, PA, 6, \$20.00	A-032-002, Wooden Shoe 1982, OH, 10, \$12.00
A-001-059, Bavarian & Columbian, XX, 6, \$15.00	A-009-032, Frieds Malt, PA, 4, \$25.00	A-021-082, Blue Ribbon Falstaff, SD, 6, \$25.00	A-032-003, Wooden Shoe 1986, FL, 10, \$8.00
A-001-060, Grafts Seal, WI, 6, \$15.00	A-012-001, Burgermeister, CA, 8, \$12.00	A-021-083, Golden Glow, CA, 6, \$20.00	A-034-003, Gilt Top, WA, 6, \$40.00
A-001-062, Manhattan Wis, WI, 6, \$12.00	A-012-002, Maier / Shriner, CA, 6, \$18.00	A-021-085, Prior, IL, 6, \$18.00	A-035-035, Miller Hipp, XX, 2, \$15.00
A-001-063, Union Malt, WI, 6, \$15.00	A-012-004, Pointer, IA, 6, \$10.00	A-021-086, Prior ILL, IL, 8, \$18.00	A-035-037, Indian Shooting Bow & Arrow, XX, 8, \$12.00
A-001-066, Stone Malt, OH, 8, \$15.00	A-012-006, Regal (Canadian), XX, 6, \$10.00	A-021-087, Rex Carlings, XX, 6, \$18.00	A-038-001, Hamms, MN, 6, \$25.00
A-001-069, Rexco Malt, WI, 6, \$18.00	A-012-010, Becker, UT, 8, \$12.00	A-021-104, Pabst Blue Ribbon, SD, 8, \$20.00	A-038-003, Blatz, WI, 4, \$25.00
A-001-071, Beloit Malt, WI, 10, \$15.00	A-012-017, Maier, CA, 8, \$15.00	A-021-110, Daniels Amber, TN, 8, \$5.00	A-038-007, Independent, PA, 6, \$25.00
A-001-072, Grafts Lemon-Life, WI, 8, \$15.00	A-012-019, Reine / S F, CA, 6, \$15.00	A-021-112, Manhattan, WI, 6, \$18.00	A-041-001, Medford, WI, 6, \$75.00
A-001-085, Manahattan (No Wis), WI, 10, \$12.00	A-012-020, O'Keefes (Canadian), XX, 6, \$10.00	A-021-113, Barbarossa Red Top, OH, 6, \$18.00	A-044-001, Cream City, WI, 8, \$20.00
A-001-085, Manhattan Milwaukee, WI, 6, \$12.00	A-012-022, Graf, WI, 4, \$15.00	A-021-119, Blatz, WI, 6, \$20.00	A-063-001, Anchor, CA, 8, \$8.00
A-001-086, Spokane, WA, 6, \$12.00	A-015-011, Leisy, IL, 6, \$18.00	A-023-001, Blackhawk, IA, 10, \$12.00	A-070-001, Cooks, IN, 4, \$5.00
A-001-090, Cudahy Malt, XX, 4, \$15.00	A-015-012, Neuweiler, PA, 8, \$22.00	A-023-003, Diamond State, DE, 10, \$18.00	C-003-001, Schlitz, WI, 4, \$35.00
A-001-106, Beloit Malt Wis (Var B), WI, 4, \$15.00	A-015-013, Terre Haute, IN, 6, \$20.00	A-023-005, Heidel Brau, IA, 10, \$18.00	C-009-017, Haddon Hall, IL, 6, \$18.00
A-001-108, Manhattan Pale Dry Ale, WI, 6, \$12.00	A-015-016, Fortune Bros / Gem Purity, IL, 4, \$18.00	A-024-001, Miller, WI, 4, \$30.00	C-009-018, Two Rivers, WI, 6, \$15.00
A-001-112, Pioneer Malt, WI, 4, \$18.00	A-015-019, Fremont (Var B), NE, 6, \$18.00	A-025-010, Pittsburgh, PA, 2, \$15.00	C-010-023, Yough, PA, 6, \$20.00
A-003-017, Collins Dietz, OK, 8, \$18.00	A-015-026, South Bend Tiger Brew, IN, 6, \$20.00	A-026-001, Empire State, NY, 6, \$40.00	C-010-026, Empire State, NY, 6, \$25.00
A-004-009, Leisy Beer, IL, 4, \$10.00	A-015-048, Cooks, IN, 6, \$12.00	A-029-001, Cosgraves Ales (Canadian), XX, 6, \$12.00	C-010-034, Old Lockport, NY, 8, \$22.00
A-004-015, Leisy Temp, IL, 4, \$8.00	A-017-012, Kamm & Schellinger / Premona, IN, 4, \$25.00	A-029-002, Eberle, MI, 6, \$15.00	C-010-045, Regal, MI, 8, \$20.00
A-004-022, Falls City (Clothed), KY, 4, \$18.00	A-017-019, Waverly, IA, 6, \$35.00	A-029-003, K-B, IL, 8, \$8.00	C-011-007, Fauerbach, WI, 6, \$15.00
A-005-002, Grafts, WI, 6, \$12.00	A-017-039, Leisy, IL, 2, \$10.00	A-029-005, Pabst (Straight), WI, 8, \$5.00	C-012-001, A B C, MO, 10, \$6.00
	A-020-039, Wayne, MI, 8, \$12.00	A-029-007, Rainier, WI, 4, \$10.00	C-012-002, Breidt, NJ, 8, \$12.00
	A-021-001, Becks, NY, 6, \$8.00	A-029-009, Schlitz, WI, 8, \$5.00	C-012-003, Camden, NJ, 6, \$6.00
	A-021-002, Blatz, WI, 10, \$5.00	A-029-014, Potosi / Potosi, WI, 8, \$12.00	C-012-004, Cremona, CT, 6, \$6.00
	A-021-003, Carling, XX, 8, \$18.00	A-029-023, Potosi / Wisconsin, WI, 6, \$12.00	C-012-006, Fidelio, NY, 6, \$5.00
	A-021-005, Duquesne, PA, 8, \$5.00	A-029-031, Butte 112 2522, MT, 6, \$12.00	C-012-007, Fort Pitt, PA, 6, \$10.00
	A-021-011, Cataract (Spinner Knob Drilled Out), NY, 2, \$8.00		C-012-008, Fort Pitt, PA, 2, \$6.00
			C-012-010, Genesee, NY, 6, \$5.00
			C-012-011, Goebel, MI, 8, \$6.00
			C-012-015, Lebanon Valley, PA,
	A-021-012, Consumers, RI, 4,		
		A-029-032, Butte Bottlers Supply,	

2, \$5.00	\$8.00	\$20.00	\$5.00
C-012-017, Neuweiler, PA, 6, \$12.00	C-012-124, Kings, NY, 6, \$4.00	C-013-293, Williams, RI, 6, \$35.00	E-004-045, Hornung, PA, 6, \$8.00
C-012-018, National, MD, 6, \$5.00	C-012-125, Knapstein 100, WI, 10, \$8.00	C-013-339, Carl Ebner Brewing Co., WI, 4, \$60.00	E-004-046, Horton, NY, 6, \$12.00
C-012-021, Piels, NY, 6, \$3.00	C-012-125, Knapstein, WI, 6, \$5.00	C-014-027, Burkhardts, OH, 6, \$8.00	E-004-047, Hudepohl, OH, 6, \$5.00
C-012-024, Rieker, PA, 6, \$10.00	C-012-128, Rainier, CA, 6, \$8.00	C-015-021, Krueger / Ambassador, NJ, 8, \$12.00	E-004-048, Humboldt, CA, 6, \$5.00
C-012-027, So Bethlehem, PA, 6, \$6.00	C-012-130, Ruppert, NY, 6, \$4.00	C-017-012, Lebanon Valley, PA, 6, \$10.00	E-004-049, Independent, IL, 6, \$1.00
C-012-030, Victor, PA, 6, \$10.00	C-012-132, Washington, OH, 4, \$4.00	C-017-041, West Bend, WI, 10, \$10.00	E-004-050, Manitowoc Products Pale, WI, 4, \$2.00
C-012-034, Alpen Brau, MO, 6, \$6.00	C-012-133, Weber, WI, 6, \$8.00	C-017-058, Stoneys, PA, 6, \$12.00	E-004-051, Koehler, PA, 6, \$4.00
C-012-035, Bobbie White Cap, WI, 6, \$8.00	C-012-136, Fort Pitt (Fort), PA, 6, \$15.00	C-017-065, Victor, PA, 6, \$12.00	E-004-051, Koehler, PA, 6, \$4.00
C-012-035, Bobbie Ale, WI, 6, \$4.00	C-012-137, Fort Pitt (Fort), PA, 6, \$8.00	C-018-018, Burkhardts, OH, 6, \$12.00	E-004-052, Krueger, NJ, 6, \$3.00
C-012-036, Bobbie Ale / Two Rivers, WI, 8, \$5.00	C-012-143, Duquesne, PA, 6, \$8.00	C-018-024, Stanton, NY, 6, \$12.00	E-004-053, Langs, NY, 8, \$2.00
C-012-042, Enterprise, MA, 8, \$10.00	C-012-144, Heigh-Ho, PA, 4, \$4.00	C-020-002, Beverwyck (Var A), NY, 8, \$15.00	E-004-054, Liebmann, NY, 4, \$5.00
C-012-043, Felsenbrau, OH, 8, \$6.00	C-012-145, Marathon City Marathon, WI, 8, \$5.00	C-020-017, Hudepohl, OH, 6, \$15.00	E-004-057, Manhattan, IL, 6, \$1.00
C-012-044, West Virginia, WV, 4, \$4.00	C-012-147, St Marys, PA, 6, \$8.00	C-020-023, Burkhardts, OH, 6, \$15.00	E-004-059, McDermott, IL, 4, \$5.00
C-012-045, Fitzgerald, NY, 6, \$6.00	C-012-147, St Marys, PA, 8, \$8.00	E-004-001, Acme Beer / Beer, CA, 6, \$6.00	E-004-059, Besser, WI, 6, \$8.00
C-012-049, Knapstein, WI, 6, \$4.00	C-012-151, Elfenbrau (You Pay Spinner), WI, 6, \$10.00	E-004-005, Arrow, MD, 6, \$2.00	E-004-061, Miller, WI, 6, \$3.00
C-012-051, Manz, PA, 8, \$10.00	C-012-153, St Marys, PA, 6, \$12.00	E-004-006, Atlantic, IL, 6, \$4.00	E-004-062, Miller Var A, WI, 4, \$3.00
C-012-052, Marathon City Tannebaum, WI, 6, \$8.00	C-012-159, Schaefer / Same, NY, 8, \$10.00	E-004-008, Atlas Lovers, IL, 6, \$3.00	E-004-063, Monarch, IL, 6, \$3.00
C-012-053, National, MD, 6, \$6.00	C-012-160, Tadcaster, MA, 6, \$5.00	E-004-009, Atlas / Imported, IL, 6, \$3.00	E-004-064, Nueustadt, PA, 4, \$8.00
C-012-055, Peerless, WI, 10, \$5.00	C-012-162, Mahattan (Maybe C-13), NY, 10, \$10.00	E-004-010, Atlas / Reach, IL, 4, \$3.00	E-004-065, Neuweiler, PA, 6, \$1.00
C-012-056, Piels, NY, 6, \$8.00	C-012-163, Franklin, OH, 8, \$8.00	E-004-011, Berghoff / Beer, IN, 6, \$5.00	E-004-066, Oldbru, MI, 6, \$8.00
C-012-057, Pilsers, NY, 6, \$12.00	C-012-166, Fox Valley, WI, 6, \$25.00	E-004-014, Blatz Drink Brew, WI, 6, \$4.00	E-004-067, Potosi, WI, 4, \$8.00
C-012-060, Schaefer, NY, 6, \$8.00	C-012-174, Crystal Rock, OH, 6, \$4.00	E-004-015, Buckeye, OH, 6, \$5.00	E-004-068, Prima Beer, IL, 6, \$5.00
C-012-063, Simon Pure, NY, 8, \$8.00	C-012-178, Wisconsin Co-Operative, WI, 6, \$18.00	E-004-016, Buffalo, CA, 6, \$5.00	E-004-069, R & H, NY, 6, \$5.00
C-012-065, Trenton, NJ, 8, \$8.00	C-013-010, Cadillac, MI, 8, \$18.00	E-004-017, Burgermeister / Golden State, CA, 8, \$4.00	E-004-070, Rainier, CA, 6, \$3.00
C-012-067, Black Forest, OH, 4, \$5.00	C-013-015, Columbus All-American, NE, 10, \$18.00	E-004-018, Bushkill, PA, 6, \$3.00	E-004-071, Rainier, CA, 6, \$3.00
C-012-068, Brockert, MA, 6, \$8.00	C-013-023, Du Bois, PA, 10, \$15.00	E-004-019, Canandaigua, NY, 6, \$8.00	E-004-072, Regal Amber Var B, CA, 6, \$4.00
C-012-072, Cleveland Home, OH, 6, \$8.00	C-013-049, Geyer, MI, 6, \$18.00	E-004-020, Centlivre Fort Wayne, IN, 4, \$3.00	E-004-073, Regal, CA, 6, \$3.00
C-012-077, Duquesne, PA, 8, \$15.00	C-013-069, Magnolia, TX, 6, \$20.00	E-004-021, Centlivre Nickel, IN, 6, \$3.00	E-004-074, Regal Var A, CA, 6, \$3.00
C-012-081, Flocks, PA, 4, \$6.00	C-013-115, Von, MI, 6, \$15.00	E-004-024, Commercial, MA, 6, \$8.00	E-004-075, Rochester, NY, 6, \$1.00
C-012-083, Gold Bond, OH, 6, \$8.00	C-013-126, Christmann, WI, 6, \$15.00	E-004-025, Coors, CO, 6, \$2.00	E-004-076, Ruppert, NY, 6, \$5.00
C-012-084, Greensburg, PA, 6, \$15.00	C-013-142, Lubeck, OH, 6, \$20.00	E-004-026, Derby, NY, 6, \$8.00	E-004-077, St Claire, CA, 6, \$5.00
C-012-087, Koehler, PA, 6, \$8.00	C-013-174, Gettelman, WI, 6, \$20.00	E-004-028, Dick Brothers Company, IL, 6, \$4.00	E-004-077, St Claire, CA, 6, \$5.00
C-012-092, Peerless (You Pay Spinner), WI, 6, \$8.00	C-013-187, Pointer / (Dog), IA, 6, \$20.00	E-004-029, Diehl Var A, OH, 4, \$6.00	E-004-078, Golden State, CA, 6, \$3.00
C-012-093, Pfeiffer, MI, 6, \$4.00	C-013-200, Wisconsin, WI, 6, \$20.00	E-004-030, Doelger First Prize, NY, 6, \$8.00	E-004-087, Star / Wooden Shoe, OH, 4, \$8.00
C-012-094, Piels, NY, 6, \$8.00	C-013-215, Dutch Club, PA, 10, \$10.00	E-004-031, Doelger Malt, NY, 6, \$6.00	E-004-093, Wagner (End Filed), IL, 4, \$4.00
C-012-096, Rainier, CA, 8, \$12.00	C-013-225, North Pole Black, WV, 6, \$22.00	E-004-033, Falls City, KY, 6, \$4.00	E-004-096, Fredericksburg, CA, 6, \$5.00
C-012-097, Riverview, WI, 6, \$8.00	C-013-255, Mexicali Malt, AZ, 8, \$12.00	E-004-034, Falls City, KY, 4, \$4.00	E-004-097, White Crown, WI, 6, \$4.00
C-012-103, Stanton, NY, 6, \$6.00	C-013-261, Class & Nachod, PA, 10, \$25.00	E-004-035, Falstaff Var A, MO, 2, \$1.00	E-004-102, Atlas / Drink Atlas, IL, 6, \$4.00
C-012-107, Two Rivers, WI, 6, \$8.00	C-013-268, South Fork, PA, 8, \$20.00	E-004-037, General, CA, 6, \$3.00	E-004-104, Burlington, WI, 6, \$12.00
C-012-108, Wagner, OH, 6, \$20.00	C-013-270, West Bend, WI, 6, \$18.00	E-004-038, Globe, MD, 4, \$3.00	E-004-105, California, CA, 6, \$3.00
C-012-111, Wagner, FL, 8, \$25.00	C-013-281, P O C, OH, 6, \$25.00	E-004-039, Golden West Golden Glow, CA, 6, \$3.00	E-004-107, Bavarian Malt, MO, 6, \$6.00
C-012-114, Washington, OH, 6, \$12.00	C-013-283, Wisconsin, WI, 6, \$20.00	E-004-040, Golden West, CA, 4, \$2.00	E-004-108, Cooks, IN, 4, \$8.00
C-012-115, Washington / Same, OH, 6, \$12.00			E-004-109, Eckerts, CA, 6, \$5.00
C-012-116, Wayne, PA, 6, \$10.00			E-004-113, Eullberg, WI, 6, \$10.00
C-012-119, Franklin, OH, 4, \$8.00			E-004-115, Fredetricksburg, CA, 6, \$5.00
C-012-121, Hold Gold / Silver Springs, WA, 6, \$5.00			E-004-117, Goetz, MO, 4, \$3.00
C-012-121, Hop Gold, WA, 8, \$5.00			E-004-118, Hauenstein, MN, 6, \$5.00

E-004-121, Humboldt Humboldt, CA, 6, \$8.00	E-004-150, Trommer Brews, NY, 6, \$4.00	E-004-225, Fitgers, MN, 6, \$10.00	E-004-279, Jackson Nic-Nac, LA, 6, \$12.00
E-004-122, Keeley, IL, 6, \$8.00	E-004-151, Wagner, IL, 6, \$8.00	E-004-228, Franklin Store Malt, XX, 4, \$8.00	E-004-282, Schmidt, MN, 4, \$3.00
E-004-123, Kingsbury, WI, 6, \$4.00	E-004-152, Wagner Augustiner, OH, 6, \$8.00	E-004-229, Humboldt Bond Street, CA, 6, \$8.00	E-004-282, Schmidt, MN, 4, \$3.00
E-004-126, Lucky, CA, 4, \$2.00	E-004-154, Wieland, CA, 6, \$6.00	E-004-235, North Star, CA, 6, \$5.00	E-004-293, Bachrach-Feld American Beauty, OH, 6, \$8.00
E-004-126, Lucky, CA, 4, \$2.00	E-004-161, Congress, NY, 6, \$8.00	E-004-236, Old Wurzburg, XX, 6, \$6.00	E-004-303, Metz, NE, 6, \$8.00
E-004-128, Oertels, KY, 4, \$10.00	E-004-167, Fisher, UT, 6, \$4.00	E-004-239, Prima 2300, IL, 4, \$5.00	E-004-304, Peerless / Carbonated, WI, 6, \$8.00
E-004-129, Pabst, WI, 6, \$4.00	E-004-170, Gold Label, WI, 6, \$10.00	E-004-240, Rainier / 5 1/2%, CA, 6, \$6.00	E-004-312, Blue Anchor Bev, XX, 6, \$8.00
E-004-132, Prima 4302, IL, 6, \$6.00	E-004-172, Hoffman, NJ, 6, \$4.00	E-004-246, Two Rivers, WI, 8, \$10.00	E-004-315, Monarch / Chi-Dry, IL, 6, \$10.00
E-004-133, Rainier In The West, CA, 6, \$5.00	E-004-174, Indianapolis (End Filed), IN, 4, \$10.00	E-004-247, Zoller, IA, 6, \$5.00	E-004-319, A & K Malt, WI, 4, \$6.00
E-004-135, Rainier Lime, CA, 6, \$12.00	E-004-176, Koerber, OH, 4, \$5.00	E-004-257, South Bend (End Filed Off), IN, 4, \$8.00	E-004-332, Eichler, NY, 8, \$10.00
E-004-136, Regal Amber Deluxe, CA, 6, \$4.00	E-004-190, Renner Old Oxford, OH, 6, \$8.00	E-004-266, Home-Ade Malt, XX, 4, \$6.00	E-004-334, High-Test Malt, IL, 6, \$6.00
E-004-137, Renner / Grossvater, OH, 6, \$4.00	E-004-192, Robin-Hood, NE, 6, \$10.00	E-004-270, Rainier Inc, CA, 2, \$4.00	E-004-344, Hustings Beverages, WI, 6, \$5.00
E-004-138, Renner Pilsener, OH, 6, \$4.00	E-004-193, S. F., CA, 6, \$12.00	E-004-276, Blitz-Weinhard, OR, 6, \$5.00	E-004-344, Hustings Beverages, WI, 6, \$5.00
E-004-144, Schorr-Kolkschneider, MO, 4, \$3.00	E-004-199, Trommers Var B, NY, 8, \$3.00	E-004-277, Eichler, NY, 6, \$4.00	E-004-999, Original Manitou / Natural Gas Carbonation, CO, 6, \$8.00
E-004-146, Sheas (Canadian), CAN, 6, \$5.00	E-004-220, Columbia, WA, 6, \$5.00	E-004-277, Eichler, NY, 8, \$4.00	
E-004-147, Standard / Ox Head,	E-004-221, Cooks Beer, IN, 6,		

Verne Vollrath Fixed Price List Results (Closed October 21/2012 16 Bidders)

A-001-001, Argonaut, CA, 6, \$21.00	E-014-061, DuBois, PA, 6, \$17.00	G-001-011, Goldenrod, NY, 6, \$10.00	G-008-018, Monarch, IL, 6, \$3.00
A-001-007, Fitgers, MN, 6, \$30.00	E-014-379, Heurich, DC, 6, \$8.00	G-001-012, Grand Prize Lager, TX, 4, \$8.00	G-008-022, Steins, NY, 6, \$5.00
A-001-011, Gutsch, WI, 6, \$60.00	E-014-412, Oertel, KY, 6, \$6.00	G-001-013, Grand Prize South, TX, 6, \$12.00	G-013-007, Old Tavern, IL, 6, \$4.00
A-003-005, Jiffy Malt Brumalt Kansas City, MO, 8, \$20.00	E-014-421, Pittsburgh, PA, 10, \$15.00	G-001-014, Grand Prize Texas, TX, 6, \$15.00	G-013-010, Rahr, WI, 6, \$4.00
A-005-033, O K Malt, WI, 6, \$7.00	E-014-461, Ballantine, NJ, 6, \$8.00	G-001-015, Hazelton, PA, 4, \$10.00	G-019-001, Bartholomay, NY, 6, \$125.00
A-007-012, Marx Cut-Rate Malt, MI, 6, \$20.00	E-014-525, National, MD, 6, \$15.00	G-001-016, Latrobe, PA, 6, \$12.00	M-020-001, Gutsch, WI, 6, \$40.00
A-012-015, 7th St Malt, PA, 6, \$15.00	E-014-574, Wehle, CT, 4, \$8.00	G-001-017, Lithia, WI, 6, \$7.00	M-080-001, Kingsbury, WI, 4, \$25.00
A-012-016, Tivoli / Greenwald, CO, 6, \$25.00	E-014-580, American, HI, 8, \$10.00	G-001-020, Old Stock, PA, 6, \$25.00	N-009-001, Camden, NJ, 6, \$8.00
A-020-039, Wayne, MI, 6, \$20.00	E-014-599, 1884 (Copper), OH, 6, \$20.00	G-001-023, Quandt, NY, 6, \$7.00	N-009-003, Fox Head (Pic of Fox), WI, 6, \$4.00
A-021-036, Consumers, XX, 8, \$31.00	E-014-600, Bechaud, WI, 6, \$20.00	G-001-025, Tru-Blu, PA, 4, \$12.00	N-009-004, Mathie-Ruder, WI, 8, \$8.00
A-021-042, Moose, PA, 6, \$35.00	E-014-609, Gunther, MD, 6, \$12.00	G-001-029, Ann Arbor, MI, 6, \$36.00	N-009-005, Muehlebach, MO, 6, \$5.00
A-021-045, Sunshine Piels, PA, 10, \$30.00	E-014-634, St Claire, CA, 8, \$16.00	G-001-032, Hoffman, NJ, 4, \$7.00	N-009-006, Neuweiler, PA, 4, \$4.00
A-021-050, Barbarossa Red Top, VA, 6, \$30.00	E-014-686, DuBois, PA, 6, \$23.00	G-001-033, Kings Var A, NY, 6, \$7.00	N-009-007, Trenton, IL, 6, \$4.00
A-021-051, Engesser, MN, 6, \$30.00	E-014-693, Hillsboro, WI, 6, \$18.00	G-001-034, Leidger, WI, 6, \$7.00	N-009-008, Vienna, OH, 6, \$4.00
A-021-105, Prima, IL, 8, \$30.00	E-014-735, Banner, MI, 4, \$10.00	G-001-035, Liebert & Obert, PA, 6, \$20.00	N-009-009, Berlin, WI, 6, \$4.00
A-021-106, Prima, CO, 6, \$30.00	E-014-754, American, HI, 8, \$17.00	G-001-036, Marathon City, WI, 6, \$7.00	N-009-010, Esslinger, PA, 8, \$4.00
A-029-026, Sugar Loaf, MN, 10, \$35.00	E-014-758, Bobbie, WI, 6, \$8.00	G-001-041, Seitz, PA, 8, \$20.00	N-009-015, Blatz, WI, 6, \$5.00
A-035-004, Buffalo, CA, 10, \$30.00	E-014-767, Burger, OH, 6, \$25.00	G-001-043, Jax, LA, 6, \$10.00	N-009-017, Green King, XX, 6, \$8.00
A-035-006, Capitol, CO, 4, \$15.00	E-014-784, Flocks, PA, 6, \$8.00	G-001-044, Keeley, IL, 6, \$7.00	N-009-021, Old Vienna, OH, 6, \$12.00
A-036-001, Triners, XX, 8, \$35.00	F-002-001, Ambrosia, IL, 4, \$4.00	G-001-049, Hand, IL, 6, \$28.00	N-009-022, Wausau, WI, 8, \$12.00
B-018-071, Shamokin, PA, 6, \$40.00	F-002-004, Frederick, IL, 8, \$4.00	G-003-002, Denmark, WI, 6, \$10.00	N-009-024, Old Fashioned, WI, 6, \$15.00
B-018-315, Tennessee, TN, 8, \$40.00	F-002-006, North Star, WI, 6, \$4.00	G-003-005, Engelking, IL, 6, \$5.00	N-009-034, Brewers Journal, NY, 8, \$12.00
B-019-173, Farmers, WI, 6, \$0.00	F-002-007, Potosi, WI, 6, \$15.00	G-003-007, Langs, NY, 6, \$5.00	N-009-035, Hustings, WI, 6, \$4.00
B-021-077, Schlitz Sheehan, PA, 4, \$40.00	F-002-012, Crystal Rock, XX, 6, \$4.00	G-003-008, Schneider, CO, 8, \$10.00	N-009-035, Hustings, WI, 6, \$4.00
B-024-014, Gipps, IL, 4, \$65.00	F-002-016, Vernon, CA, 8, \$15.00	G-003-009, Ye Tavern, IN, 6, \$10.00	N-009-048, Mathie-Ruder Gold Star (w/ Box), WI, 10, \$20.00
B-024-019, Howell & King, PA, 6, \$90.00	F-002-020, American Dry, MD, 6, \$5.00	G-003-010, Zollers, IA, 6, \$7.00	P-080-001, Froedtert / Malt, WI, 6, \$60.00
B-024-024, Mineral Spring Brewing, WI, 4, \$75.00	F-002-024, Gluek, MN, 6, \$10.00	G-003-014, Silver Foam, MI, 8, \$20.00	
B-024-084, Badger Brand, WI, 4, \$75.00	F-002-025, Iroquois, NY, 8, \$22.00	G-008-007, Marathon City, WI, 6, \$3.00	
	F-002-030, Nectar, IL, 8, \$10.00	G-008-013, Gluek, MN, 6, \$3.00	
	F-002-033, Missoula, MT, 6, \$15.00	G-008-014, Manru, NY, 6, \$5.00	
	F-002-034, Rainier, CA, 6, \$5.00	G-008-015, Pioneer, WI, 6, \$5.00	
	F-002-037, Pabst, WI, 6, \$10.00		
	F-002-040, Harrison, NJ, 6, \$15.00		
	F-002-JL, Gluek Brewing Co. (Not Company) / Indian Maid Ginger Ale, MN, 8, \$40.00		
	G-001-001, A B C, XX, 6, \$4.00		
	G-001-004, Buckeye, OH, 6, \$12.00		
	G-001-007, Ebling Only, NY, 6, \$4.00		

Remember on the Fixed Price List you can "Make Offers"!

JUST FOR OPENERS

35th ANNUAL CONVENTION REGISTRATION

APRIL 10-14, 2013

Holiday Inn Select Opryland/Airport (Nashville TN 37214)
 2200 Elm Hill Pike
 1-866-871-1171 (National) or 1-615-883-9770 (Local)

(Rate is \$95.00 for a Single, Double or Quad)
 (Rate Good for 3 Days Before and 3 Days After Convention)
 (Hotel Cutoff Date is March 9th 2013)

(Tell them you are with the Just For Openers Group)
(Note Airport Shuttle is Provided Free)

MAKE NASHVILLE YOUR NEXT STOP ON THE JFO CONVENTION TRAIL

MEMBER REGISTRATION FEE - **\$50.00**
 (MEMBER INCLUDES HOSPITALITY ROOM, CONVENTION OPENER & 1 SHOW TABLE)
 SPOUSE/PARTNER - **\$10.00 (Total Member & Spouse/Partner \$60)**
 (SPOUSE/PARTNER INCLUDES USE OF HOSPITALITY ROOM) (NOTE:CHILDREN ARE FREE)

NAME _____

ADDRESS _____

CITY _____ STATE(PROVINCE) _____ ZIP _____

EVENING PHONE NUMBER _____

DATE YOU WILL ARRIVE _____ APPROXIMATE TIME _____

DATE & TIME YOU WILL LEAVE _____ (NEED FOR PLANNING PURPOSES)

HOW WILL YOU ARRIVE? CAR ___ PLANE ___ TRAIN ___ OTHER _____

IF PLANE? AIRLINE _____ FLIGHT # _____ ETA _____

NAME(S) FOR CONVENTION BADGE(S): _____

HOSPITALITY ROOM DRINK Brands: Beer: _____ Soda/Water: _____

MAKE CHECKS PAYABLE TO John Stanley, Send Checks to:
 JFO 35 PO Box 51008 Durham NC 27717
 Phone (919) 824-3046

******* BRING A DISPLAY !!!*******

“35th Just For Openers Convention Registration (Page 2)”

Convention Wish List

**List up to 10 Openers/Corkscrews,
Send in with Registration Form,
A master list will be Emailed Out**

01) _____	06) _____
02) _____	07) _____
03) _____	08) _____
04) _____	09) _____
05) _____	10) _____

**The 35th JFO Convention is Going to be a Thrill
It's in the Fun City of Nashville**

**Come With Music in Your Soul
With Plenty of Openers in Tow**

**Enjoy the Friendships that have Grown Over the Years
With Those People we have Shared Laughter and Tears**

**You Will Leave with a Song in Your Heart
And a Bigger Love for Openers than You Had at the Start**

**Don't Forget to Bring an Opener Display
Without Those we Would be Dismayed**

**Pat and John Will Be in the Hospitality Room
Hope to See You There Very Soon!!!**