

Just For Openers January-December 2025 1

Stephens Eclectic Pocket Tools

By Don Thornton

In the early 1900s, inventor Augustus W. Stephens made things a bit better for beer, soda and milk drinkers, wine enthusiasts, cigar smokers and strawberry eaters. From 1901 through 1911 Stephens, of Cambridge and later Waltham, Massachusetts, was awarded at least ten patents that resulted in several small pocket tools, most for advertising purposes, made by his A.W. Stephens Manufacturing Company or his Windsor Stephens & Company.

Stephens' February 19, 1901 Design Patent No. 34,096 for a bottle opener with a flat handle ("Place your ad here!") was produced by his Waltham factory. Over the years dozens and dozens of breweries, soda companies and food firms branded it with their names. One example, among hundreds, was for **BEECHNUT BRAND CATSUP**. The 3-inch pocket opener is also marked on the curved back handle: **TRADE PICNIC MARK REG. U.S. PAT. OFF.**

Feb. 19, 1901. A. W. Stephens Des. 34,096
BOTTLE SEAL REMOVER
Filed Jan. 21, 1901

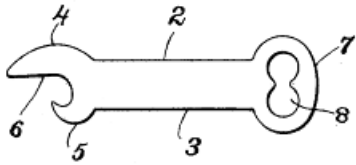

WITNESSES:

A.H. Brown,
H. Joseph Doyle

INVENTOR:

Augustus W. Stephens

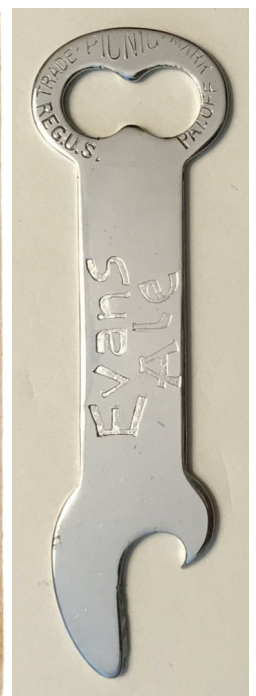
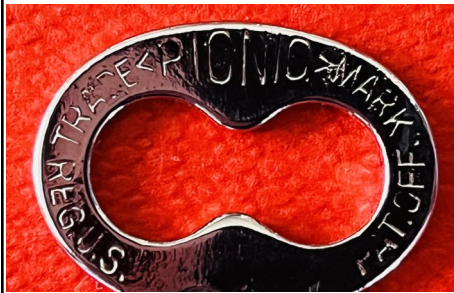

Just For Openers January-December 2025 2

Stephens Eclectic Pocket Tools

By Don Thornton

Next up was a combination bottle opener, corkscrew and knife based on a patent assigned to Stephens by John D. Baseler of Richmond, Virginia. The April 30, 1901 Patent No. 673,153 for a “stopper extractor” had a flat side for advertising. One advertiser among scads of others was **EVERETT BREWING CO. EVERETT, WASHINGTON.**



April 30, 1901. J. D. Baseler
STOPPER EXTRACTOR
Filed Aug. 8, 1899 673,153

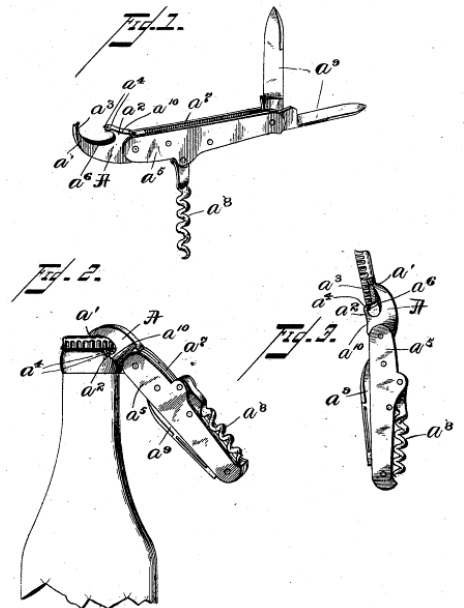

WITNESSES

Marcus L. Byng.
Allan St. Huss.

INVENTOR

John D. Baseler
By his Atty
Mason F. Smith



The April 30, 1901 bottle opener design patent also graced Stephens’ “All-Ways Handy Combination Bottle Opener & Corkscrew.” That patent date and another one, by a different inventor, was cited in the literature in the original box the tool came in. The second patent date was October 16, 1900, Patent No. 659,649, for a “machine for making corkscrews” and not a corkscrew. That patent was awarded to William Rockwell Clough of Alton, New Hampshire, a prolific and famous corkscrew and related items inventor. The explanation is that the machine made the corkscrew used in the “ALL-WAYS.”

Just For Openers January-December 2025 3

Stephens Eclectic Pocket Tools

By Don Thornton

One unbranded example of the 6-inch combo tool is marked **ALL-WAYS HANDY COMBINATION BOTTLE OPENER & CORK SCREW** THE CANCELLING POINT PUTS A HOLE IN THE TIN CAP, ALLOWING YOU TO RELEASE GAS GRADUALLY, AND THUS PREVENTS SPURTING OF CONTENTS. WINDSOR STEPHENS CO. WALTHAM, MASS. PA. APRIL 30, 1901.

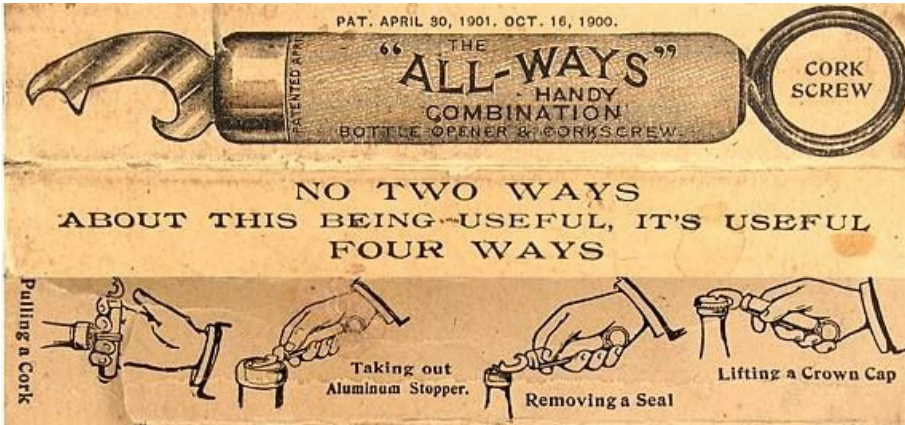

Oct. 16, 1900. W. R. Clough 659,649
MACHINE FOR MAKING CORKSCREWS
Filed Mar. 5, 1900

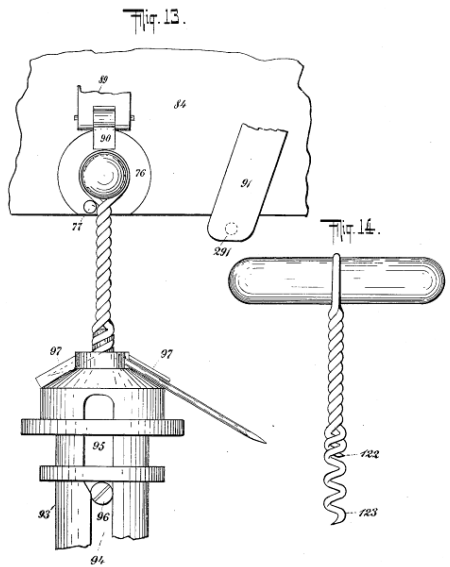

Witnesses:
Gunder Lunderson,
Charles G. Bortolotta

Inventor:
William Rockwell Clough,
By
Chas. O. Gill
Attorney.



A few years later Stephens switched to strawberries and a real grabber -- his December 18, 1906 Patent No. 838,662 strawberry huller. Only 2 3/8 inches long and 7/8 of an inch wide, this small device was a giant success nationwide at the turn of the 20th Century. Stephens said his invention was "composed of a sheet of strip metal bent crosswise at the center of its length to form two normally diverging arms ... to cooperate as the jaws adapted to bite into a strawberry and sever the hull from the body of the berry." Stephens named it the "NIP-IT" and was so proud of the name he obtained a trademark for it on April 30, 1906.

Just For Openers January-December 2025 4

Stephens Eclectic Pocket Tools

By Don Thornton

It was marked **THE NIP-IT STRAWBERRY HULLER PAT'D DEC. 18, 1906** on one side with the other open for advertising. A few models are also marked: **PIN FEATHER PICKER**. Branding ads included **USE EGG BAKING POWDER FOR SHORTCAKES, FORBES QUALITY COFFEE** and **McKENZIES MAGIC BISCUIT FLOUR**. An advertisement in *House Furnishing Review* in 1910 said "It's easier, quicker, cleaner than the old way."

Dec. 18, 1906. A. W. Stephens 838,662
STRAWBERRY HULLER
 Filed May 1, 1906

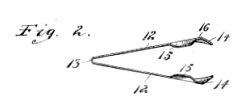
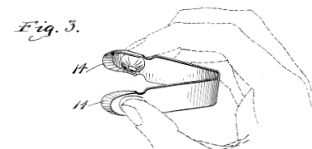

Witnesses
 L. C. Harvey
 J. G. ...
 Inventor
 A. W. Stephens
 40 ...

Ser. No. 19,195. (CLASS 23. HAND-TOOLS NOT OTHERWISE CLASSIFIED.) WINDSOR STEPHENS & CO., Waltham, Mass. Filed Apr. 30, 1906.

NIP-IT

Particular description of goods.—Strawberry-Hullers.

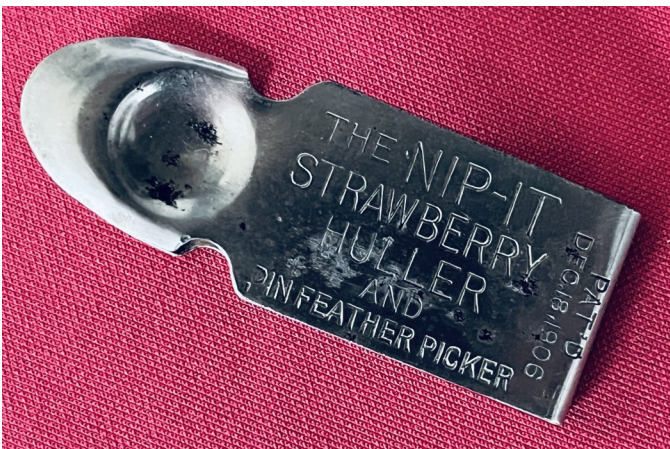

Just For Openers January-December 2025 5

Stephens Eclectic Pocket Tools

By Don Thornton

Stephens then switched to milk. His March 26, 1907 Patent No. 848576 was a "bottle opener and stopper" for milk drinkers whose milk at the time came mostly in bottles with thick paper disk tops. *Hardware Dealers' Magazine* magazine said in a 1908 article: "It is of wood in the form of a cork, made flaring, with a pointed wire inserted at the bottom of same. Taking out the paper caps on top of milk bottles frequently brings disastrous results to the person handling same. With this device the hook or prong easily enters the paper cap and it can be readily taken off. The device then acts as a stopper by being placed in the neck of the bottle." A 1909 ad in *House Furnishing Review* listed the retail price at 5 cents. Another ad in 1909 offered a free pocket opener to retailers who inquired about Nip-It and milk bottle stopper samples.

Mar. 26, 1907. A. W. Stephens 848,576
BOTTLE OPENER AND STOPPER
Filed Jan. 15, 1907

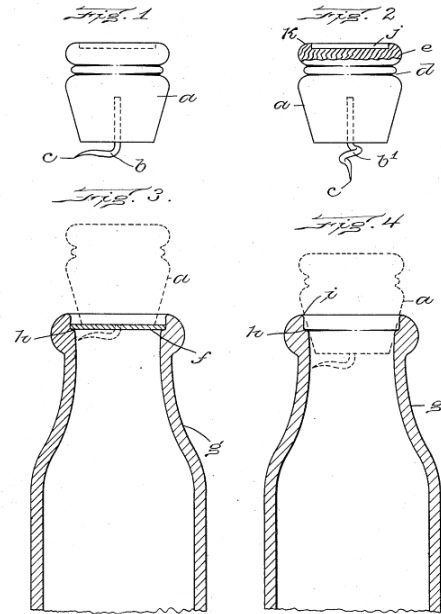

Witnesses:
B. W. Glenner,
A. C. Retigan

Selector
Augustus W. Stephens
by W. B. Brewster, Attorney.

A COMMON MISHAP AND THE PREVENTATIVE

EVERY GOOD HOUSEKEEPER KNOWS THAT MILK SHOULD BE COVERED AND SHE KNOWS WHY.

THIS DEVICE SELLS FOR A NICKEL

IF YOU HAVE ANY DOUBT OF ITS MERIT, SEND FOR SAMPLE AND TRY IT OUT IN YOUR OWN HOME. THAT'LL SETTLE IT.

THE NIP-IT Milk Bottle Opener and Stopper

GETTING A MISHAP

Get a Souvenir Free

The attention of the trade is called to the liberal offer made by Windsor Stephens & Co., Waltham, Mass. To all dealers who write for a sample of their "Nip-It" strawberry huller, or the "Open-Close" milk bottle stopper, the souvenir here illustrated will be sent free of cost. The items made by Windsor Stephens & Co. are popular sellers and need only to be shown to find a ready sale.

WINDSOR STEPHENS & CO. WALTHAM (THE WATCH CITY) MASS. ORDER THE NIP-IT OF YOUR JOBBER

WINDSOR STEPHENS & CO.
Patentees and Manufacturers
WALTHAM, MASS.

HERE'S ANOTHER NIMBLE NICKEL WINNER

THE **NIP-IT** STRAWBERRY HULLER

By its use one avoids stained fingers, seeds under finger nails, crushed fruit; keeps berries whole for table use; takes out soft spots, etc.

It's Easier, Quicker, Cleaner than the old way.

WITH SAMPLE OF EITHER THIS, OR THE MILK BOTTLE OPENER, WE WILL SEND YOU A VERY USEFUL SAUVENIR

Stephens later refined the opener, eliminating the wood stopper, adding a small handle and calling it "The Dainty Milk Bottle Opener." An ad in 1913 in *Milk Dealer* magazine shouted "MILK DEALERS—ATTENTION! We have the most economical and

effective advertising ever offered for your trade." The 3 1/2-inch tool is marked: **THE DAINTY MILK BOTTLE OPENER & CAP HANDLE.**



Milk Dealers-Attention!

We Have The Most Economical and Effective Advertising Ever Offered For Your Trade

THE DAINTY Milk Bottle Opener



As Dainty as a Piece of Jewelry

Just a neat, practical little household utility, trimmed of all needless parts and of all needless size—just a strong point and a guard and a handle big enough for the attractive display of your advertisement—so neat, so "petite" that everybody instinctively names it the "Dainty"—that's the new advertising article you have been looking for to put your announcement permanently and economically into the home—

THE DAINTY is the aristocrat of all Milk Bottle Openers

Stamped in one piece from tempered steel, neatly finished and highly nickel-plated. Nothing that can get out of order—simple, sanitary—no creases or corners to hold impurities.

You cannot give the housewife anything that will be more appreciated, more constantly used, more constantly seen than the "Dainty".

In lots of a thousand 2 cents each (larger quantities less price) including stamping your advertisement.

Place your selling message, your name, your slogan, in the home to stay.

The Dainty is the most economical and effective advertising ever offered.



SEND A TWO-CENT STAMP FOR A SAMPLE TODAY

A. W. STEPHENS MFG. CO., Waltham, Mass.

ORIGINATORS, PATENTEES AND MANUFACTURERS THE WATCH CITY
ILLINOIS GLASS CO., 402-406 W. Randolph St., Chicago; Western Distributors.
ILLINOIS-PACIFIC GLASS CO., San Francisco; Pacific Coast Distributors.

Stephens Eclectic Pocket Tools

By Don Thornton

Stephens next patent resulted in a bit of intrigue surrounding his relationship with Clough. The patent in question was No. 889,556, dated June 2, 1908, for a “cigar tip perforator” with a wooden cylinder or sheath to protect “a perforating pin.” The cylinder was open-ended, “with a cavity to receive one end of a cigar” to allow the penetration of the pin. The patent also said the sheaf is “adapted to serve as a storage receptacle for another article, such as a cork screw, the whole being adapted to be carried in the pocket of the user.”



This combo tool was discovered in 2007 by collector Mark Woodward, who reported the similarities of Stephen’s tool and William Rockwell Clough’s 1910 wood sheath bottle opener/corkscrew combo. (See *Stephens Corkscrew Cigar Perforator JFO New 2024.*)

It should be pointed out that Stephens applied for his patent November 8, 1907 and it was granted June 2, 1908. Clough applied for his patent October 16, 1907, and

it was granted March 1, 1910. Thus Clough was first out of the gate – if it matters, as all the evidence points to a business relationship and not patent poaching.

An interesting fact: Stephens had two other “bottle cap remover” patents, both awarded in 1911 that had wood sheaths “for a corkscrew.” Patent No. 982,893 said the wood handle would “receive and serve as a sheath for a corkscrew.” Patent No. 999,901 said the “inexpensive device” was “adapted also to be used as a sheath for a corkscrew and carried in the pocket.” Neither patent drawing showed a worm, and it is believed neither opener made it past the patent stage. No known examples.

June 2, 1907. A. W. Stephens 889,556
CIGAR TIP PERFORATOR
Filed Nov. 8, 1907

Fig. 1.

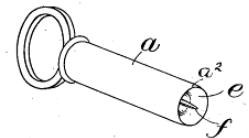

Fig. 2.

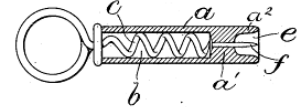
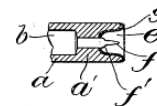

Fig. 3.



Witnesses:
Forest Rowlett
E. Batchelder

Inventor:
A. W. Stephens
by *W. R. Clough*
Attorney

Mar. 1, 1910. W. R. Clough 950,509
BOTTLE CAP LIFTER
Filed Oct. 10, 1907

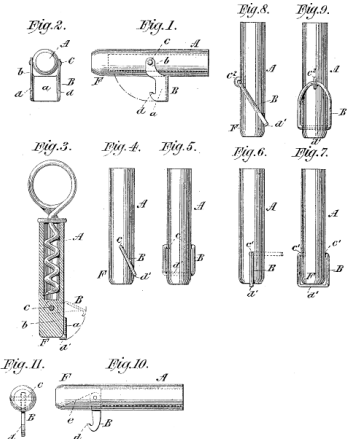

WITNESSES:
Charles Rowlett
Raven Thibault

INVENTOR:
William Rockwell Clough
BY *W. R. Clough*
ATTORNEY

Just For Openers January-December 2025 8

Stephens Eclectic Pocket Tools

By Don Thornton

Stephens was awarded three patents in 1911 and regrettably the next year he passed away. No obituary appeared in local or any Massachusetts newspapers. Unfortunately, the only public record readily available on this important inventor and manufacturer was the Waltham City Directory of 1912, which listed his death on November 22 of that year.

SIDEBAR: Stephens apparently was so enamored with his pocket opener he even patented a "package for implements," or display case, for its free distribution. This is how Stephens explained his 1907 Patent No. 857,767: "This invention has for its object to provide means for putting up in attractive forms for free distribution or other disposal, useful and inexpensive articles or implements such as are commonly distributed free of charge for advertising purposes."

He also touted his opener and the practice of branding, saying: "An example of this class of articles is a bottle cap remover stamped from a flat metal plate, and provided with jaws to engage a sheet metal bottle cap or crown, and with an orifice to adapt it to receive a key ring. Bottle openers of this character are distributed as advertisements by dealers in bottle goods, the dealer's advertisement being stamped upon a flat surface of the bottle opener."

May 31, 1910. A. W. Stephens 959,897
STOPPER EXTRACTOR
Filed Apr. 2, 1910

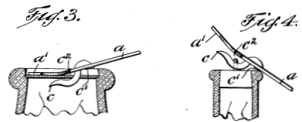
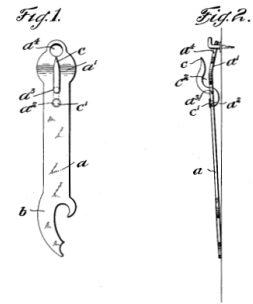

Witnesses:
Harry L. Allen
Frederic W. Plimpton

Inventor:
Augustus W. Stephens;
by H. L. Allen, Attorney
at Law

Left: Stephens Envelope Cover and a Stephens Letterhead.

A. W. STEPHENS MANFG. CO.

(ADVERTISING POCKET CORKSCREW HEADQUARTERS)

ADVERTISING SPECIALTIES

WALTHAM, MASS.
(THE WATCH CITY)

June 25, 1907. A. W. Stephens 857,767
PACKAGE FOR IMPLEMENTS
Filed Mar. 21, 1907

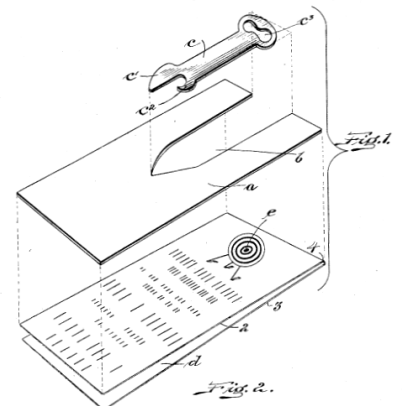

Witnesses:
L. C. Schiffer
H. J. ...

Inventor:
A. W. Stephens
by H. J. ... Attorney

